



botter[®]

ELECTRICAL TECHNOLOGY SINCE 1943





Botter Elettrotecnica è un'azienda leader nella produzione di trasformatori elettrici e macchine elettriche statiche. Nata nel 1943 dalla volontà e capacità del cav. Rino Botter, è oggi una realtà in continua crescita che accanto ad attrezzature tecnologicamente all'avanguardia lavora nel rispetto delle recenti normative ambientali e di sicurezza. Nel nuovo e moderno stabilimento vengono prodotti trasformatori di diverse potenze destinati ad essere impiegati in applicazioni specifiche che spaziano dal campo dell'automazione industriale, a quello medico e ferroviario, alla distribuzione di energia elettrica, al campo delle fonti energetiche rinnovabili. Nel corso degli anni l'azienda ha saputo soddisfare ogni genere di richiesta attraverso un programma di investimenti in ricerca e sviluppo, volto a implementare nuove tecnologie produttive e ricercare i migliori materiali e risorse per la realizzazione dei propri prodotti. Botter Elettrotecnica, oltre alla certificazione UNI EN ISO 9001:2015 inerente la qualità dei propri processi produttivi, può esibire tre certificazioni UL per la produzione di macchine secondo gli standard UL 5085 (General purpose low voltage transformers – Industrial control transformers) e UL 1446 (Systems of insulating materials), due certificazioni EAC per il mercato euroasiatico, cui si affiancano altre due certificazioni ENEC prova della conformità alle norme CEI (EN 61558). I trasformatori seguono inoltre le prescrizioni della direttiva “bassa tensione” 2014/35/UE.

I principali campi di applicazione dei prodotti realizzati sono:

- Automazione industriale;
- Impiantistica civile ed industriale;
- Realizzazione di linee di produzione;
- Distribuzione dell'energia;
- Fotovoltaico, eolico e fonti rinnovabili in generale;
- Macchine utensili;
- Elettronica;
- Medica;
- Ferroviario;
- Automatismi (aperture automatiche, basculanti, sbarre, ecc.);
- Videocitofonia



Attuale stabilimento



Botter Elettrotecnica is a leading company in electrical transformers and static electrical machines. Founded in 1943 by ability and will of knight Rino Botter, is today a growing reality that, in addition to technologically advanced equipment, works in compliance with recent environmental and safety regulations. In the new and modern plant different transformers are manufactured intended to be used in specific applications ranging from industrial automation, to medical and railway, distribution and renewable energy.

Over the years the company has been able to satisfy every kind of request through a program of investments in research and development aimed at implementing new production technologies, and search the best materials and resources for the manufacturing of products.

Botter Elettrotecnica, in addition to the UNI EN ISO 9001: 2015 certification concerning production processes, organization, has two UL certifications for transformer manufacturing according to standards UL 5085 (General purpose low voltage transformers) and UL 1446 (Systems of insulating materials), two certification EAC for euroasiatic community, three more ENEC certifications, proof of compliance with CEI standards (EN 61558).

Transformers are also manufactured in compliance with Low-Voltage Directive 2014/35/UE.

Botter transformers are mainly addressed to the following industrial sectors:

- *Industrial automation;*
- *Civil and industrial electrical nets and installations;*
- *Production lines manufacturing;*
- *Energy distribution;*
- *Photovoltaic, wind and renewable energy sources in general;*
- *Machinery manufacturing;*
- *Electronics;*
- *Medical instruments and machines manufacturing;*
- *Railways installations;*
- *Home and building automation (entrances and doors automation, swinging doors, etc.);*
- *Video doorbell entrance systems.*



Current plant

Sommario

SOMMARIO	4
NORMATIVE DI RIFERIMENTO	8
DEFINIZIONI	9
CLASSIFICAZIONE DEI SISTEMI A BASSISSIMA TENSIONE	11
CLASSI DEI COMPONENTI ELETTRICI	11
CLASSE TERMICA DEI TRASFORMATORI	12
GRADI DI PROTEZIONE IP	14
TRASFORMATORI	18
<hr/>	
TRASFORMATORI MONOFASE	19
TRASFORMATORI MONOFASE DI SICUREZZA UL "INSULATION SYSTEM"	21
TRASFORMATORI MONOFASE DI ISOLAMENTO UL "INSULATION SYSTEM"	23
TRASFORMATORI MONOFASE DI SICUREZZA	24
TRASFORMATORI MONOFASE DI ISOLAMENTO	28
TRASFORMATORI MONOFASE "UL RECOGNIZED"	30
TRASFORMATORI MONOFASE "UL LISTED"	33
TRASFORMATORI MONOFASE OMOLOGATI ENEC	35
TRASFORMATORI MONOFASE OMOLOGATI ATEX	36
TRASFORMATORI MONOFASE PER GUIDA DIN	37
TRASFORMATORI MONOFASE DI SICUREZZA PER GUIDA DIN	38
TRASFORMATORI MONOFASE DI ISOLAMENTO PER GUIDA DIN	39
TRASFORMATORI MONOFASE DI SICUREZZA PER LAMPADE ALOGENE	40
TRASFORMATORI MONOFASE DI SICUREZZA IN CLASSE II	41
TRASFORMATORI MONOFASE PER CIRCUITO STAMPATO	42
TRASFORMATORI MONOFASE RESINATI PER CIRCUITO STAMPATO	43
TRASFORMATORI MONOFASE CON CONNESSIONE FAST-ON	44
TRASFORMATORI MONOFASE DI ISOLAMENTO SCHERMATI	45
TRASFORMATORI MONOFASE DI ISOLAMENTO PER USO MEDICALE	46
TRASFORMATORI MONOFASE DI ISOLAMENTO PER RETI FERROVIARIE	47
TRASFORMATORI TOROIDALI	48
TRASFORMATORI TRIFASE	52
<hr/>	
COLLEGAMENTI DEI TRASFORMATORI TRIFASE	54
TRASFORMATORI TRIFASE DI SICUREZZA	55
TRASFORMATORI TRIFASE DI ISOLAMENTO	56
TRASFORMATORI TRIFASE DI ISOLAMENTO IN BOX	57
TRASFORMATORI TRIFASE "UL RECOGNIZED"	58
TRASFORMATORI TRIFASE "UL LISTED"	62
TRASFORMATORI TRIFASE DI ISOLAMENTO PER IMPIANTI FOTOVOLTAICI ED EOLICI	64
TRASFORMATORI TRIMONOFASE	68
<hr/>	

AUTOTRASFORMATORI	70
AUTOTRASFORMATORI MONOFASE	71
AUTOTRASFORMATORI MONOFASE "UL RECOGNIZED"	76
AUTOTRASFORMATORI MONOFASE "UL LISTED"	78
AUTOTRASFORMATORI TRIFASE	80
AUTOTRASFORMATORI TRIFASE "UL RECOGNIZED"	83
AUTOTRASFORMATORI TRIFASE "UL LISTED"	86
REATTANZE	88
NOTE GENERALI SULLE REATTANZE PER AVVIAMENTO MOTORE	90
REATTANZE PER AVVIAMENTO MOTORI ASINCRONI TRIFASE	91
INDUTTANZE TRIFASE DI FILTRO "IN USCITA"	93
INDUTTANZE TRIFASE DI FILTRO "IN INGRESSO"	94
ALIMENTATORI	95
ALIMENTATORI MONOFASE AC/DC LIVELLATI COMPATTI	97
ALIMENTATORI MONOFASE AC/DC LIVELLATI	98
ALIMENTATORI MONOFASE AC/DC STABILIZZATI	99
ALIMENTATORI TRIFASE AC/DC LIVELLATI	100
ACCESSORI	101
NOTE,STOCCAGGIO, GARANZIE, URGENZE	108

Summary

SUMMARY	6
REFERENCE STANDARDS	8
DEFINITIONS	9
EXTRA-LOW VOLTAGE SYSTEMS CLASSIFICATION	11
ELECTRICAL COMPONENT CLASSES	11
TRANSFORMER THERMAL CLASSES	12
IP PROTECTION DEGREES	14
TRANSFORMERS	18
SINGLE-PHASE TRANSFORMERS	19
UL "INSULATION SYSTEM" SINGLE-PHASE SAFETY TRANSFORMERS	21
UL "INSULATION SYSTEM" SINGLE-PHASE ISOLATING TRANSFORMERS	23
SINGLE-PHASE SAFETY TRANSFORMERS	24
SINGLE-PHASE ISOLATING TRANSFORMERS	28
"UL RECOGNIZED" SINGLE-PHASE TRANSFORMERS	30
"UL LISTED" SINGLE-PHASE TRANSFORMERS	33
ENEC APPROVED SINGLE-PHASE TRANSFORMERS	35
ATEX APPROVED SINGLE-PHASE TRANSFORMERS	36
DIN RAIL CASE SINGLE-PHASE TRANSFORMERS	37
DIN RAIL CASE SINGLE-PHASE SAFETY TRANSFORMERS	38
DIN RAIL CASE SINGLE-PHASE ISOLATING TRANSFORMERS	39
SINGLE-PHASE TRANSFORMERS FOR HALOGEN LAMPS	40
SINGLE-PHASE CLASS II SAFETY TRANSFORMERS	41
SINGLE-PHASE TRANSFORMERS FOR PRINTED CIRCUITS	42
SINGLE-PHASE CAST-RESIN TRANSFORMERS FOR PRINTED CIRCUITS	43
SINGLE-PHASE TRANSFORMERS WITH FAST-ON CONNECTION	44
ISOLATING SCREENED SINGLE-PHASE TRANSFORMERS	45
SINGLE-PHASE ISOLATING TRANSFORMERS FOR MEDICAL LOCATIONS	46
SINGLE-PHASE ISOLATING TRANSFORMERS FOR RAILWAY SYSTEMS	47
TOROIDAL TRANSFORMERS	48
THREE-PHASE TRANSFORMERS	52
THREE-PHASE TRANSFORMER CONNECTIONS	54
THREE-PHASE SAFETY TRANSFORMERS	55
THREE-PHASE ISOLATING TRANSFORMERS	56
THREE-PHASE CASED ISOLATING TRANSFORMERS	57
"UL RECOGNIZED" THREE-PHASE TRANSFORMERS	58
"UL LISTED" THREE-PHASE TRANSFORMERS	62
THREE-PHASE ISOLATING TRANSFORMERS FOR PHOTOVOLTAIC AND WIND POWER SYSTEMS	64
THREE-SINGLE-PHASE TRANSFORMERS	68

AUTOTRANSFORMERS	70
SINGLE-PHASE AUTOTRANSFORMERS	71
“UL RECOGNIZED” SINGLE-PHASE AUTOTRANSFORMERS	76
“UL LISTED” SINGLE-PHASE AUTOTRANSFORMERS	78
THREE-PHASE AUTOTRANSFORMER	80
“UL RECOGNIZED” THREE-PHASE AUTOTRANSFORMERS	83
“UL LISTED” THREE-PHASE AUTOTRANSFORMERS	86
REACTORS	88
GENERAL NOTES ABOUT ON MOTOR STARTING REACTORS	90
STARTING REACTORS FOR ASYNCHRONOUS THREE-PHASE MOTORS	91
THREE-PHASE OUTPUT FILTERING REACTORS	93
THREE-PHASE INPUT FILTERING REACTORS	94
POWER SUPPLIES	95
AC/DC LEVELLED COMPACT SINGLE-PHASE POWER SUPPLY UNITS	97
AC/DC LEVELLED SINGLE-PHASE POWER SUPPLY UNITS	98
AC/DC STABILIZED SINGLE-PHASE POWER SUPPLY UNITS	99
AC/DC LEVELLED THREE-PHASE POWER SUPPLY UNITS	100
ACCESSORIES	101
NOTES, STORAGE, WARRANTY, URGENT SUPPLIES	108

NORMATIVE DI RIFERIMENTO REFERENCE STANDARDS

I trasformatori BOTTER sono progettati, costruiti e collaudati secondo le norme EN attualmente in vigore.

BOTTER transformers are designed, manufactured and tested according to current EN standards.

DESCRIZIONE	NORMA STANDARD	DESCRIPTION
Sicurezza dei trasformatori, delle unità di alimentazione e simili Parte 1: Prescrizioni generali e prove	EN 61558-1	<i>Safety of power transformers, power supplies units and similar Part 1: General requirements and tests</i>
Sicurezza dei trasformatori, delle unità di alimentazione e simili Parte 2-1: Prescrizioni particolari per trasformatori di separazione per uso generale	EN 61558-2-1	<i>Safety of power transformers, power supplies units and similar Part 2-1: Particular requirements for separating transformers for general use</i>
Sicurezza dei trasformatori, delle unità di alimentazione e simili Parte 2-2: Prescrizioni particolari per trasformatori di comando	EN 61558-2-2	<i>Safety of power transformers, power supplies units and similar Part 2-2: Particular prescription for control transformers</i>
Sicurezza dei trasformatori, delle unità di alimentazione e simili Parte 2-4: Prescrizioni particolari per trasformatori d'isolamento	EN 61558-2-4	<i>Safety of power transformers, power supplies units and similar Part 2-4: Particular requirements for isolating transformers</i>
Sicurezza dei trasformatori, delle unità di alimentazione e simili Parte 2-6: Prescrizioni particolari per trasformatori di sicurezza	EN 61558-2-6	<i>Safety of power transformers, power supplies units and similar Part 2-6: Particular requirements for safety transformers</i>
Sicurezza dei trasformatori, delle unità di alimentazione e simili Parte 2-13: Prescrizioni particolari per autotrasformatori	EN 61558-2-13	<i>Safety of power transformers, power supplies units and similar Part 2-13: Particular requirements for autotransformers</i>
Sicurezza dei trasformatori, delle unità di alimentazione e simili Parte 2-15: Prescrizioni particolari per trasformatori d'isolamento per alimentazione di locali ad uso medico	EN 61558-2-15	<i>Safety of power transformers, power supplies units and similar Part 2-15: Particular requirements for isolating transformers for supply of medical locations</i>
Sicurezza dei trasformatori, delle unità di alimentazione e simili Parte 2-20: Prescrizioni particolari per piccoli reattori	EN 61558-2-20	<i>Safety of power transformers, power supplies units and similar Part 2-20: Particular requirements for small reactors</i>
Trasformatori di potenza Parte 1: Generalità	EN 60076-1	<i>Power transformers Part 1: General</i>
Trasformatori di potenza Parte 6: Reattori	EN 60076-6	<i>Power transformers Part 6: Reactors</i>
Trasformatori di potenza Parte 11: Trasformatori di tipo a secco	EN 60076-11	<i>Power transformers Part 11: Dry-type transformers</i>
Trasformatori per uso generale	UL 5085	<i>General purpose transformers / Industrial control transformer</i>
Materiali per sistemi di isolamento	UL 1446	<i>Systems of insulating materials</i>
"Sulla sicurezza di apparecchiature a bassa tensione"	TR CU 004/2021	<i>"Safety of low-voltage equipment"</i>

I prodotti BOTTER non sono interessati dalla direttiva comunitaria 2014/30/UE riguardante la compatibilità elettromagnetica poiché componenti a basso livello di emissioni elettromagnetiche.

BOTTER products are not interested by 2014/30/UE community directive related to electromagnetic compatibility because they are low-level electromagnetic emissions components.

DEFINIZIONI DEFINITIONS

TRASFORMATORE: macchina statica che per induzione elettromagnetica trasforma, mantenendo invariata la frequenza di ingresso, tensioni e correnti alternate fra due o più avvolgimenti generalmente a valori diversi sia di tensione che di corrente (gli avvolgimenti primario e secondario sono elettricamente separati).

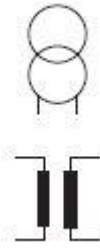

TRANSFORMER: static electrical machine that changes, by electromagnetic induction, voltages and currents between two or more windings, usually with different values of voltage and current, keeping the same input frequency (primary and secondary windings are electrically separated).

AUTOTRASFORMATORE: trasformatore in cui gli avvolgimenti primari e secondari hanno una parte in comune (soluzione economica qualora non fosse necessario separare elettricamente l'avvolgimento collegato alla rete da quello collegato all'utilizzatore).



AUTOTRANSFORMER: transformer where primary and secondary windings have a common part (cheap solution if it is not necessary to have an electrical separation of the winding connected to the network from the one connected to the user).

TRASFORMATORE DI ISOLAMENTO: trasformatore con una separazione di protezione fra gli avvolgimenti primari e secondari, atta a limitare i pericoli dovuti a contatti accidentali fra massa e parti sotto tensione e fra le parti metalliche in caso di cedimento dell'isolamento

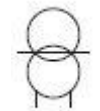

ISOLATING TRANSFORMER: transformer with protective separation between the input and output windings, designed to minimize the dangers rising from accidental contacts between live parts and ground and between the metal parts in case of insulation breakdown.

TRASFORMATORE DI SICUREZZA: trasformatore di isolamento destinato ad alimentare circuiti a bassissima tensione ($\leq 50V_{ac}$ o $\leq 120V_{cc}$ piatta)

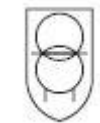

SAFETY TRANSFORMER: isolating transformer designed to supply extra-low voltage circuits ($\leq 50V_{ac}$ or $\leq 120V$ ripple-free dc).

TRASFORMATORE DI COMANDO: trasformatore destinato all'alimentazione di circuiti di comando, caratterizzato da uno specifico valore di potenza istantanea erogabile al carico.



CONTROL TRANSFORMER: transformer intended to supply power to control circuits, characterized by a specific value of instantaneous power that may be supplied to load.

TRASFORMATORE CON SCHERMO: trasformatore in cui gli avvolgimenti primari sono separati dagli avvolgimenti secondari attraverso una lastra avvolta come una spira aperta e isolata e collegata ad un conduttore di protezione. Il suo scopo principale è quello di abbattere i disturbi provenienti dalla rete di alimentazione e far sì che non si ripercuotano nel circuito secondario.

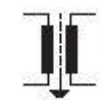

TRANSFORMER WITH ELECTRIC SHIELD: transformer where primary windings are separated from secondary windings by a plate wrapped as an open wire, insulated and connected to a protection conductor. Its main purpose is to breakdown the noise coming from the power supply and ensure that they will not affect the secondary circuit.

TRASFORMATORE ASSOCIATO: trasformatore progettato per alimentare apparecchi o apparecchiature specifiche o parti di essi.

TRASFORMATORE INCORPORATO: trasformatore associato adatto ad essere incorporato in un apparecchio specifico o apparecchiature specifiche il cui involucro fornisce la protezione contro la scossa elettrica (a cura dell'installatore).

TRASFORMATORE PROTETTO CONTRO IL CORTOCIRCUITO NON PER COSTRUZIONE: trasformatore provvisto di un dispositivo di protezione che apre il circuito primario o secondario quando il trasformatore è sovraccaricato o cortocircuitato.

TRASFORMATORE NON PROTETTO CONTRO IL CORTOCIRCUITO: trasformatore sprovvisto di dispositivi di protezione che intervengano in caso di sovraccarico o di cortocircuito.

REATTANZA: dispositivo che comprende uno o più avvolgimenti, che funziona in conformità al principio di autoinduzione (usata normalmente per l'avviamento di motori asincroni oppure come filtro per la pulizia dell'onda in ingresso o in uscita da inverter).

ALIMENTATORE: trasformatore al quale viene applicata della componentistica atta a raddrizzare e livellare (in taluni casi anche stabilizzare) il segnale in modo da ottenere in uscita una tensione continua.

ASSOCIATED TRANSFORMER: transformer designed to supply specific apparatus, equipment or part of them.

INCORPORATED TRANSFORMER: associated transformer suitable to be incorporated in a specific apparatus or equipment where the enclosure itself provides the protection against electric shocks (provided by the installer).

NON-INHERENTLY SHORT-CIRCUIT PROOF TRANSFORMER: short-circuit proof transformer equipped with a protective device that opens primary or secondary circuit in case of overload or short-circuit.

NON-SHORT-CIRCUIT PROOF TRANSFORMER: transformer not equipped with any protective device that acts in case of overload or short-circuit.

REACTOR: electrical device working by magnetic self-induction principle, designed with one or more windings (normally used for asynchronous motors starting or as a filter for cutting electrical noise that affects sinusoidal waves at inverter inputs or exits).

POWER SUPPLY UNIT: transformer at which exit terminals some components are applied, with the result of changing a sinusoidal input current (AC) into a continuous current (DC) at a given output voltage (in some cases the output voltage can be also stabilized).



CLASSIFICAZIONE DEI SISTEMI A BASSISSIMA TENSIONE EXTRA-LOW VOLTAGE SYSTEMS CLASSIFICATION

La norma CEI 64-1 definisce tre sistemi a bassissima tensione, i quali si differenziano in base al tipo di protezione contro i contatti diretti ed indiretti. Per questi sistemi il limite di tensione è fissato in 50 V c.a. ed in 120 V in c.c. piatta (sistemi ELV).

CIRCUITI SELV: circuito ELV con separazione di protezione dagli altri circuiti e che non ha dispositivi per la messa a terra del circuito e nemmeno per le altre parti conduttrici esposte.

CIRCUITI PELV: circuito ELV con separazione dagli altri circuiti e che per ragioni funzionali può essere collegato a terra e/o le cui parti conduttrici esposte possono essere a loro volta collegate a terra.

CIRCUITI FELV: circuito ELV avente una bassissima tensione ma che non soddisfa tutte le prescrizioni per essere SELV o PELV.

Standards define three extra-low voltage systems, which differ each other for the protection they ensure against direct and indirect contacts.

The voltage limit for the three systems is 50 V a.c. or 120 V ripple free d.c. (ELV circuit).

SELV CIRCUIT: *ELV circuit with protective separation from other circuits, and which has no provisions for earthing of the circuit nor of the exposed conductive parts.*

PELV CIRCUITS: *ELV circuit with protective separation from other circuits and which, for functional reason, may be earthed and/or the exposed conductive parts of which may be earthed.*

FELV CIRCUITS: *extra-low-voltage circuit not fulfilling all requirements to be SELV or PELV.*

CLASSI DEI COMPONENTI ELETTRICI ELECTRICAL COMPONENT CLASSES

I componenti elettrici sono normalmente suddivisi secondo il loro modo di protezione contro i contatti indiretti in tre diverse classi: CLASSE I, II, III.

TRASFORMATORE DI CLASSE I: trasformatore dotato di isolamento principale e provvisto di altri dispositivi di sicurezza, per esempio attraverso il collegamento delle masse ad un conduttore di protezione.

TRASFORMATORE DI CLASSE II: trasformatore dotato di doppio isolamento o isolamento rinforzato e non provvisto di alcun tipo di dispositivo di sicurezza per la messa a terra.

TRASFORMATORE DI CLASSE III: trasformatore in cui la protezione consiste nell'essere alimentato e nel produrre bassissime tensioni (SELV).

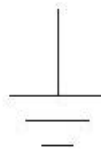

Electrical components are usually divided in three different classes, CLASS I, II, III according to their protection level against indirect contacts.

CLASS I TRANSFORMER: *transformer equipped with basic insulation and provided with other safety devices, for instance the connection of the masses to a protection conductor.*

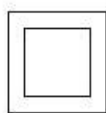

CLASS II TRANSFORMER: *transformer equipped with double or reinforced insulation and not provided with no ground connection.*



CLASS III TRANSFORMER: *transformer where the protection lies on the fact that its power supply voltage and its output voltage are extremely low (SELV).*

CLASSE TERMICA DEI TRASFORMATORI TRANSFORMER THERMAL CLASSES

Le norme stabiliscono le temperature limite che i materiali isolanti possono sopportare al fine di evitare il veloce deterioramento o la distruzione degli stessi. A tale scopo sono state definite le CLASSI TERMICHE, identificate da lettere. Ciascuna lettera, a sua volta, indica la temperatura massima a cui ciascun materiale isolante può essere sottoposto senza deteriorarsi.

La temperatura ambiente di riferimento è 25° C.

International standards fix the temperature limits which isolating materials must bear without damages or losing any one of their properties. Some THERMAL CLASSES named with specific letters were identified for this scope. Each letter, then, is related to a temperature value.

Reference ambient temperature is 25 °C.

CLASSI TERMICHE THERMAL CLASSES	SOVRATEMPERATURA OVERTEMPERATURE [°C]	TEMPERATURA MASSIMA MAX TEMPERATURE [°C]
A	75	100
E	90	115
B	95	120
F	115	140
H	140	165
C	>140	>165

Botter Elettrotecnica può produrre trasformatori in qualsiasi classe termica, e con temperature ambiente di riferimento maggiori a 25 °C. I trasformatori descritti in questo catalogo vengono realizzati nelle classi "B", "F" ed "H".

Botter Elettrotecnica is equipped for the manufacturing of transformers belonging to any one of the thermal classes, and taking in consideration ambient temperatures even higher than 25 °C. Transformers described in this catalogue are manufactured in compliance with "B", "F" and "H" thermal classes.

POTENZA PRELEVABILE IN FUNZIONE DELLA TEMPERATURA AVAILABLE POWER ACCORDING TO TEMPERATURE

La massima potenza prelevabile dal secondario del trasformatore è quella indicata nella targa dello stesso ed è riferita alla temperatura ambiente di 25 °C (temperatura alla quale lavora il trasformatore). Nel caso in cui la temperatura sia maggiore è necessario tenere conto del declassamento di potenza come da grafico sottostante (senza mai oltrepassare i 65 °C).

The maximum available power at transformer output connections is the one displayed on the transformer label, and it is referred to a 25 °C ambient temperature (transformer working temperature). If ambient temperature is higher than 25 °C, it is necessary to downgrade transformer rated power according to the following graph (without exceeding 65 °C).

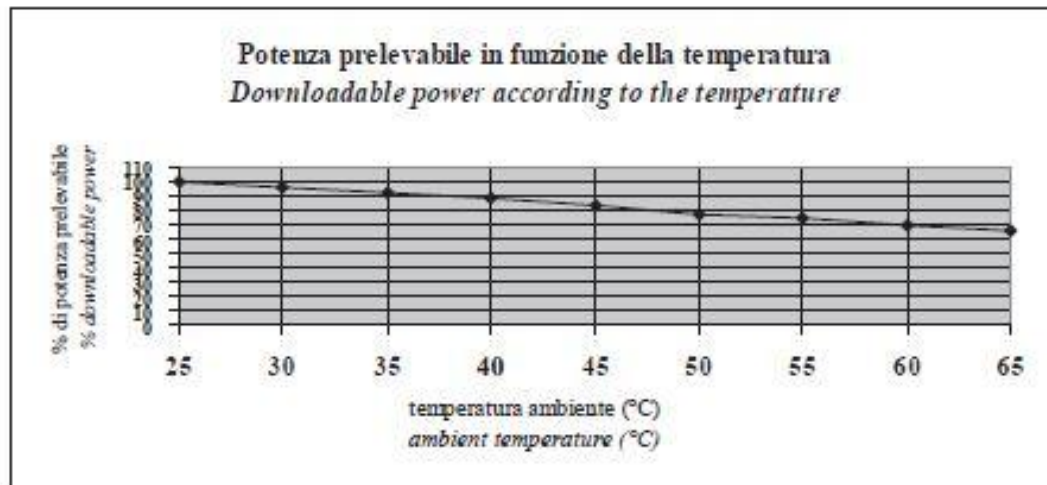

POTENZA DI SPUNTO PRELEVABILE IN FUNZIONE DELLA NOMINALE INRUSH & RATED POWER DOWNLOADING RATIO

Nel caso in cui il trasformatore debba alimentare carichi prevalentemente induttivi come motori elettrici, contattori, o relè, sarà necessario considerare la potenza di spunto che il trasformatore potrà erogare. Il grafico sottostante dà indicazioni per la scelta del trasformatore più adeguato, considerando un carico a $\cos\phi=0,5$.

In case the transformer has to supply inductive loads such as electrical motors, contactors or relays, it is necessary to consider the inrush power the transformer has to comply with. With following graph we give a hint to choose the most appropriate transformer, considering $\cos\phi=0,5$ power factor.

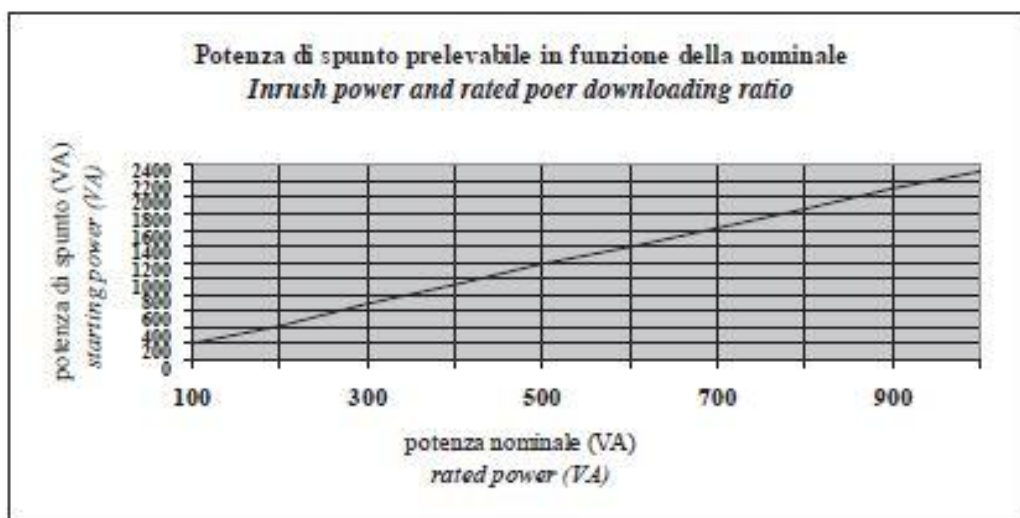

GRADI DI PROTEZIONE IP IP PROTECTION DEGREES

I trasformatori Botter possono essere costruiti con diversi gradi di protezione IP (International Protection). Il grado di protezione standard è IP00 ("a giorno"). Altri possibili gradi di protezione sono: IP20 – IP23 – IP44 – IP54 – IP55 – IP56 – IP65– IP66, in base alla tipologia di box in cui il trasformatore viene installato. In accordo alla norma EN 60529 desideriamo ricordare brevemente il significato delle cifre IP con la seguente tabella (la prima cifra IP riguarda la protezione dell'involucro contro la penetrazione di corpi estranei, la seconda contro i liquidi).

Botter transformers may be manufactured with different IP protection degrees (International Protection).

IP00 is the standard protection degree. Other possible protection degrees may be IP20 – IP23 – IP44 – IP54 – IP55 – IP56 – IP65– IP66, according to the box type where the transformer is intended to be installed. We wish to briefly mention the meaning of the IP code with the following table in compliance with EN 60529 standard (the first IP number concerns the protection of the case against foreign bodies while the second against liquids).

PRIMA CIFRA		FIRST NUMBER
Non protetto	0	Not protected
Protetto contro corpi solidi di diametro superiore a 50 mm	1	Protected against solid objects with diameter greater than 50 mm
Protetto contro corpi solidi di diametro superiore a 12,5 mm	2	Protected against solid objects with diameter greater than 12,5 mm
Protetto contro filo di diametro superiore a 2,5 mm	3	Protected against wire with diameter greater than 2,5 mm
Protetto contro filo di diametro superiore a 1,0 mm	4	Protected against wire with diameter greater than 1,0 mm
Protetto contro la polvere entro una certa misura	5	Protected against dust within a limited extent
Totalmente protetto contro la polvere	6	Totally protected against dust

14

SECONDA CIFRA		SECOND NUMBER
Non protetto	0	Not protected
Protetto contro gocce d'acqua a caduta verticale	1	Protected against vertically dripping water
Protetto contro gocce d'acqua a caduta con inclinazione di 15°	2	Protected against dripping water falling with 15° inclination
Protetto contro gocce d'acqua a caduta con inclinazione di 60°	3	Protected against dripping water falling with 60° inclination
Protezione contro gli spruzzi da qualsiasi direzione	4	Protected against splashing water from any direction
Protezione contro i getti da qualsiasi direzione	5	Protected against water jets from any direction
Protezione contro i getti potenti da qualsiasi direzione (ondate)	6	Protected against powerful water jets from any direction (waves)
Protetto contro gli effetti di un'immersione temporanea	7	Protected against the effects of temporary immersions in water
Protetto contro gli effetti dell'immersione continua	8	Protected against the effects of continuous immersion in water

VARIE OTHERS

FREQUENZA: Il trasformatore, per la sua natura di macchina elettrica statica, non può modificare la frequenza della tensione di uscita rispetto a quella della tensione di ingresso. Per questo motivo la frequenza entrante nel trasformatore è anche la frequenza uscente.

È importante sottolineare che un trasformatore progettato per lavorare a 50 Hz è in grado di lavorare anche a 60 Hz. Tutti i trasformatori Botter a catalogo sono progettati per funzionare sia a 50 Hz che a 60 Hz.

Il valore della frequenza nominale di funzionamento, è di fondamentale importanza nel caso in cui si debbano costruire delle reattanze: essa è il parametro più importante che consente l'adeguato dimensionamento della macchina.

Su specifica richiesta, Botter Elettrotecnica può realizzare reattanze con valori di frequenza nominale diversi da 50 Hz.

VERNICE: Tutti i trasformatori Botter sono impregnati per immersione totale e adeguatamente tropicalizzati con vernici in classe F/H.

POTENZA: In caso di trasformatori con più secondari, la potenza totale nominale è data dalla somma delle singole potenze di ogni secondario.

Se un secondario presenta invece delle prese intermedie, la piena potenza può essere prelevata solo dalla presa più alta, mentre le prese intermedie hanno potenza passante (su specifica richiesta si possono realizzare tutte le prese a piena potenza e/o con uso contemporaneo).

FREQUENCY: The transformer, as a static electrical machine, cannot change output frequency in comparison to input frequency, so the input frequency is also the output one.

It is important to underline that a 50 Hz transformer, can work at 60 Hz too. All Botter transformers are designed to work both at 50 and 60 Hz frequency.

Rated frequency is also very important in inductors designing: knowing the correct value is fundamental for theirs project development.

On specific request transformers and inductors can be designed and manufactured with rated frequency values different from 50 Hz.

VARNISHING: All Botter transformers are impregnated and tropicalized by using F or H class varnishes.

POWER: In case of transformers with more than one secondary winding, the transformer total rated power is the sum of each winding rated power.

If a secondary winding has one or more intermediate taps, the total rated power is referred to the tap with highest voltage value (upon specific request it is possible to design transformers where the rated power is available at each one of the intermediate exits of one winding, or where it is possible to use more than one winding taps at the same time).

NOTE GENERALI PER UTILIZZO ED INSTALLAZIONE GENERAL REMARKS FOR USE AND INSTALLATION

- 1) Rispettare tutti i dati di targa apposti sull'apparecchio (potenza nominale, tensione nominale, frequenza nominale, ecc.);
- 2) Utilizzare cavi di alimentazione e di uscita di sezione adeguata e conformi alle norme relative all'apparecchiatura in cui il trasformatore viene incorporato;
- 3) Serrare accuratamente le viti dei morsetti di collegamento in maniera che il conduttore non possa sfilarsi durante il normale funzionamento provocando archi o scariche elettriche dannose, o possa introdurre una resistenza di contatto tale da far aumentare in maniera abnorme la temperatura nel punto di giunzione. Non applicare una coppia di serraggio eccessiva alle viti dei morsetti, per non danneggiarne la filettatura;
- 4) Maneggiare il trasformatore rispettando le norme vigenti; non afferrare le parti plastiche, i morsetti ed i cavi;

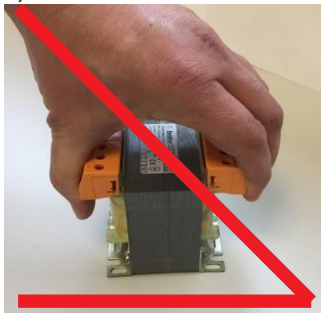

- 1) *Respect rating values on transformer label (power, voltages, frequency, etc...);*
- 2) *Use input and output cables of suitable section, in compliance with equipment manufacturing standards where the transformer is going to be embedded;*
- 3) *Tighten properly the connecting terminal screws in order to avoid conductors to slip off by accident: this event may cause dangerous electrical discharges or introduce high value contact resistance which will increase abnormally the temperature in contact points. Do not apply undue tightening torque to terminal screws, so to avoid thread damages;*
- 4) *Handle the transformer according to the current standards; do not catch transformer by plastic parts, terminals or cables;*

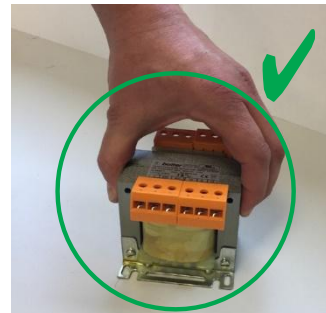

- 5) Se l'alimentazione è derivata da una rete trifase, proteggere il trasformatore con un interruttore bipolare dedicato e non mediante un interruttore tripolare;
- 6) Posizionare il trasformatore lontano da fonti di calore ed evitare di posizionare a contatto più trasformatori;
- 7) Qualora il trasformatore venga alloggiato in un involucro chiuso (cassetta, quadro, ecc.), provvedere ad un'adeguata aerazione o dimensionare l'involucro anche in funzione del calore prodotto dal trasformatore;
- 8) In caso di montaggio in luoghi aventi temperature ambiente elevate provvedere ad un'adeguata ventilazione;
- 9) Evitare l'installazione diretta in ambienti umidi se non si provvede ad una idonea protezione;
- 10) Qualsiasi variazione della tensione di alimentazione del primario si ripercuote con lo stesso valore percentuale sulla tensione di uscita del secondario;

- 5) *If transformer power supply is drawn by a three-phase electrical net, use a two poles switch for transformer protection, and not a general three phase line switch;*
 - 6) *Place the transformer far away from heat sources and do not place more transformers in contact one against the other;*
 - 7) *If the transformer is installed in a closed case (box, cabinet, etc.), provide it with an appropriate ventilation or study the case dimensions in function of transformer heat production;*
 - 8) *If the transformer is installed in high temperature ambient, provide it with an adequate cooling system;*
- Do not install the transformers in humid places without a suitable protection;*
- 9) *Every input voltage variation affects the output voltage with the same variation percentage;*

- 11) Il trasformatore è progettato per un servizio del 50% con un carico pari al valore nominale, rispettando questa condizione si ottengono valori di rendimento ideali e basse temperature (naturalmente abbassando il carico rispetto al valore nominale di targa del trasformatore, la percentuale di continuità del servizio aumenta);
- 12) Il trasformatore è progettato per poter funzionare ad una frequenza di 50 o 60 Hz – si precisa che non ha alcuna funzione di trasformare questi valori;
- 13) Evitare di collegare due o più trasformatori in parallelo, se non forniti su specifica richiesta;
- 14) La potenza nominale di targa è riferita a $\cos\phi=1$ e alla tensione nominale secondaria massima (vede re esempio figura seguente);

- 11) *Transformer is designed for a 50% duty cycle. Ideal efficiency values and low temperatures are reached by observing this disposition (the duty cycle percentage is increased by lowering the load respect to the rated value);*
- 12) *The transformer is designed to work with a frequency of 50 or 60 Hz – it cannot provide frequency change;*
- 13) *Do not connect transformers in parallel, if they were not ordered fir this scope;*
- 14) *Transformer rated power is referred to a $\cos\phi = 1$ condition and to the maximum secondary rated voltage (see drawing);*

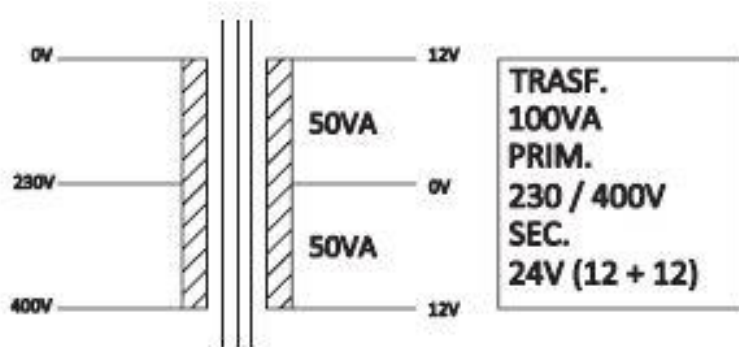

- 15) L'installazione deve essere eseguita da personale qualificato;
- 16) Il trasformatore e la linea di alimentazione devono essere protetti dal verificarsi di condizioni di cortocircuito e sovraccarico. La scelta della protezione deve tenere in debita considerazione la corrente di inserzione.

- 15) *Transformer installation must be carried out by qualified personnel;*
- 16) *Both transformer and power supply line must be protected to prevent overloading and short-circuit conditions. This choice must be done according to the in-rush current.*

TRASFORMATORI

TRANSFORMERS

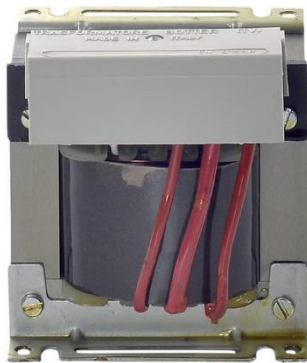
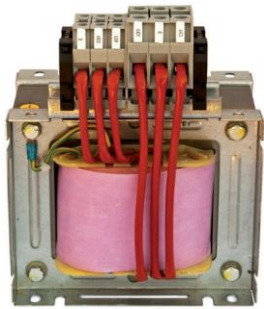

CARATTERISTICHE GENERALI GENERAL FEATURES

- Trasformatore non protetto contro i contatti diretti ed indiretti, destinato ad essere incorporato in incogniti equipaggiamenti elettrici;
 - Trasformatore non protetto contro il cortocircuito;
 - Grado di protezione contro i contatti diretti IP00 secondo le norme EN 60529;
 - Trasformatore destinato ad una installazione fissa;
 - Temperatura ambiente; -25 °C / +40 °C;
 - Classe di sovratemperatura: B/F/H;
 - Classe di isolamento: B/F/H;
 - Costruzione secondo le norme europee EN 61558 oppure EN 60076;
 - Nucleo magnetico in lamierino al silicio a bassa cifra di perdita;
 - Trasformatore tropicalizzato con vernici essiccanti in aria o a forno in classe H;
 - Avvolgimenti in filo di rame o alluminio smaltato con resine in classe H (180 °C);
 - Varie posizioni di montaggio permesse dalla particolare conformazione del supporto metallico;
 - Materiali e componenti usati per la realizzazione del trasformatore sono certificati e conformi alle relative norme;
 - Per quantitativi elevati, a richiesta del cliente, è possibile ottenere certificazioni di conformità di Istituti Europei e Nordamericani;
 - **TUTTI I TRASFORMATORI POSSONO ESSERE COSTRUITI CON SISTEMA DI ISOLAMENTO OMOLOGATO UL SECONDO LA NORMA UL 1446 "Systems of insulating materials".**
- *Transformers not protected against direct and indirect contacts, intended to be incorporated in unknown electric equipment;*
 - *Transformers non-short-circuit proof;*
 - *IP00 protection degree against direct contacts according to EN 60529 standard;*
 - *Transformers intended for fix installation;*
 - *Ambient temperature: -25 °C / +40 °C;*
 - *Temperature class: B/F/H;*
 - *Insulation class: B/F/H;*
 - *Manufacturing according to EN 61558 or EN 60076 standards;*
 - *Lamination core manufactured using silicon steel sheets characterized by low power losses;*
 - *Transformers tropicalized by using H class varnish; drying process by natural air or by oven;*
 - *H class (180°C) magnetic copper or aluminium wire windings;*
 - *Different assembling layouts due to a big number of available brakes;*
 - *Materials and components used for transformer manufacturing are certified and conforming to their standards;*
 - *For high quantity supplies, under customer specific request, it is possible to obtain conformity certifications issued by the major European and North American institutes;*
 - ***ALL TRANSFORMERS MAY BE MANUFACTURED WITH UL HOMOLOGATED INSULATION SYSTEM ACCORDING TO UL 1446 STANDARD "Systems of insulating materials".***

FUSIBILI DI PROTEZIONE E DISSIPAZIONE MASSIMA AID TABLE FOR FUSES CHOICE AND POWER DISSIPATION

Potenza Power [VA]	Primario / Primary				Secondario / Secondary					Dissipazioni Dissipation [W]
	230 V		400 V		12 V	24 V	48 V	110 V	230 V	
	RES .	IND .	RES .	IND .						
30	0,16	0,4	0,1	0,315	2,5	1,25	0,63	0,315	0,16	5
50	0,25	0,63	0,16	0,5	5	2	1	0,5	0,25	8
75	0,4	1	0,2	0,63	6,3	3,15	1,6	0,8	0,4	10
100	0,5	1,25	0,315	0,8	10	5	2,5	1	0,5	12
150	0,8	2	0,4	1,25	12	6,3	3,15	1,6	0,8	16
200	1	2,5	0,63	1,6	16	10	5	2	1	20
250	1,25	3,15	0,8	2	20	12	6,3	2,5	1,25	25
300	1,6	4	0,8	2,5	25	12	6,3	3,15	1,6	30
350	1,6	5	1	3,15	32	16	8	4	1,6	32
400	2	5	1,25	3,15	35	16	10	4	2	35
500	2,5	6,3	1,6	4	40	20	12	5	2,5	38
600	3,15	8	1,6	5	50	25	12	6,3	3,15	42
800	4	10	2,5	6,3	63	35	16	8	4	60
1000	5	10	3,15	8	80	40	20	10	5	70
1500	8	12	5	10	125	63	32	12	8	90
2000	10	16	6,3	12	160	80	40	16	10	112
2500	12	20	8	12	200	100	50	20	12	135
3000	12	25	10	16	250	125	63	25	12	145
4000	16	35	12	20	315	160	80	35	16	185
5000	25	40	12	25	400	200	100	40	20	250

RES . = CARICO RESISTIVO

IND . = CARICO INDUTTIVO

- Tutti i fusibili si intendono di tipo ritardato;
- Con sfondo evidenziato fusibili tipo 5x20 in vetro non disponibili o con portate non normalizzate; si consiglia di scegliere fusibili di tipo aM;
- Per la protezione possono essere utilizzati, in alternativa ai fusibili, anche interruttori automatici;
- I dispositivi di protezione devono essere conformi alle relative norme;
- La dissipazione si intende indicativa per il calcolo della temperatura all'interno di quadri elettrici;
- Per caratteristiche non comprese nella tabella applicare, per interpolazione, lo stesso principio di calcolo.

RES . = RESISTIVE LOAD

IND . = INDUCTIVE LOAD

- All fuses are time-delay type;
- Blue background cells indicate 5x20 glass fuses which may be unavailable or of non-standard values; we recommend the use of aM-type fuses;
- Automatic switches in place of fuses, are also helpful for transformer protection;
- Protection devices must be conforming to their own standards;
- Dissipation values are indicative and useful only for temperature calculation inside electrical cabinet;
- For powers not included in the tab, it is possible to calculate dissipation value by interpolation.

TRASFORMATORI MONOFASE DI SICUREZZA UL "INSULATION SYSTEM" UL "INSULATION SYSTEM" SINGLE-PHASE SAFETY TRANSFORMERS

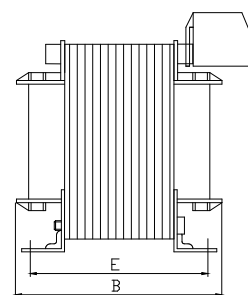
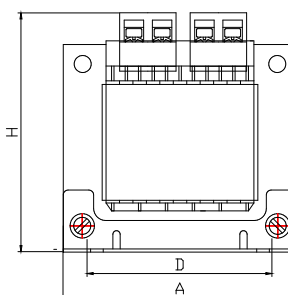
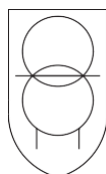

Trasformatore associato non resistente al cortocircuito
Trasformatore da incorporare in apparati elettrici specifici

*Associated transformer non-short-circuit proof
Transformer for special electric equipment*

Norme di riferimento: EN 61558-2-6; UL 1446
Frequenza: 50/60 Hz
Classe termica: F
Classe di isolamento: F
Tensione primaria: 0/230/400 V
Tensione secondaria: 12 V
Tensione secondaria: 12/0/12 V (0/12/24 V)

*Reference standards: EN 61558-2-6; UL 1446
Frequency: 50/60 Hz
Thermal class: F
Insulation class: F
Primary voltage: 0/230/400 V
Secondary voltage: 12 V
Secondary voltage: 12/0/12 V (0/12/24 V)*

CODICE PART NUMBER	POTENZA POWER [VA]	SECONDARIO SECONDARY [V]	Larghezza Width A [mm]	Profondità Depth B [mm]	Altezza Height H [mm]	Fissaggio Fixing D [mm]	Fissaggio Fixing E [mm]	Peso Weight [kg]	Imballo multiplo Multiple pack [pz - pcs]
TBTMS00112	30	12	75	72	75	55	50	1,1	12
TBTMS00124	30	12/0/12	75	72	75	55	50	1,1	12
TBTMS00412	50	12	75	78	75	55	56	1,3	12
TBTMS00424	50	12/0/12	75	78	75	55	56	1,3	12
TBTMS00812	63	12	75	87	75	55	65	1,4	12
TBTMS00824	63	12/0/12	75	87	75	55	65	1,4	12
TBTMS00712	75	12	75	87	75	55	65	1,5	12
TBTMS00724	75	12/0/12	75	87	75	55	65	1,5	12
TBTMS01012	100	12	84	92	82	60	69	2,1	8
TBTMS01024	100	12/0/12	84	92	82	60	69	2,1	8
TBTMS01312	150	12	96	98	92	68	71	3,0	8
TBTMS01324	150	12/0/12	96	98	92	68	71	3,0	8
TBTMS01612	200	12	96	112	92	68	85	3,8	6
TBTMS01624	200	12/0/12	96	112	92	68	85	3,8	6
TBTMS01912	250	12	120	102	112	80	70	4,4	6
TBTMS01924	250	12/0/12	120	102	112	80	70	4,4	6
TBTMS02212	300	12	120	114	112	80	82	5,5	6
TBTMS02224	300	12/0/12	120	114	112	80	82	5,5	6
TBTMS02512	350	12	120	114	112	80	82	5,3	6
TBTMS02524	350	12/0/12	120	114	112	80	82	5,3	6
TBTMS02812	400	12	120	122	112	80	90	6,3	4
TBTMS02824	400	12/0/12	120	122	112	80	90	6,3	4
TBTMS03112	500	12	120	134	112	80	102	7,3	4
TBTMS03124	500	12/0/12	120	134	112	80	102	7,3	4
TBTMS03512	630	12	150	130	150	80	78	8,5	4
TBTMS03524	630	12/0/12	150	130	150	80	78	8,5	4
TBTMS04012	800	12	150	150	150	80	96	10,4	4
TBTMS04024	800	12/0/12	150	150	150	80	96	10,4	4
TBTMS04612	1000	12	150	150	150	80	96	10,8	4
TBTMS04624	1000	12/0/12	150	150	150	80	96	10,8	4

TRASFORMATORI MONOFASE DI SICUREZZA UL "INSULATION SYSTEM" UL "INSULATION SYSTEM" SINGLE-PHASE SAFETY TRANSFORMERS

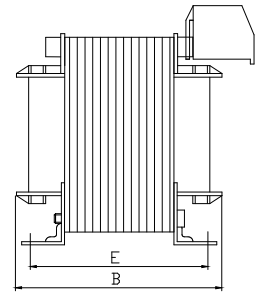
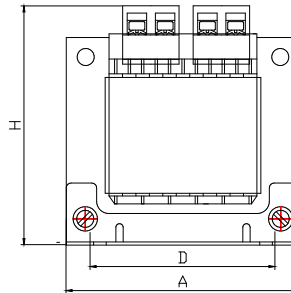
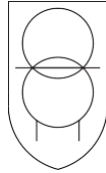

Trasformatore associato non resistente al cortocircuito
Trasformatore da incorporare in apparati elettrici specifici

Associated transformer non-short-circuit proof
Transformer for special electric equipment

Norme di riferimento: EN 61558-2-6; UL 1446
Frequenza: 50/60 Hz
Classe termica: F
Classe di isolamento: F
Tensione primaria: 0/230/400 V
Tensione secondaria: 24/0/24 V (0/24/48 V)
Tensione secondaria: 0/19/24 V

Reference standards: EN 61558-2-6; UL 1446
Frequency: 50/60 Hz
Thermal class: F
Insulation class: F
Primary voltage: 0/230/400 V
Secondary voltage: 24/0/24 V (0/24/48 V)
Secondary voltage: 0/19/24 V

CODICE PART NUMBER	POTENZA POWER [VA]	SECONDARIO SECONDARY [V]	Larghezza Width A [mm]	Profondità Depth B [mm]	Altezza Height H [mm]	Fissaggio Fixing D [mm]	Fissaggio Fixing E [mm]	Peso Weight [kg]	Imballo multiplo Multiple pack [pz - pcs]
TBTMS00148	30	24/0/24	75	72	75	55	50	1,1	12
TBTMS0011924	30	19/24	75	72	75	55	50	1,1	12
TBTMS00448	50	24/0/24	75	78	75	55	56	1,3	12
TBTMS0041924	50	19/24	75	78	75	55	56	1,3	12
TBTMS00848	63	24/0/24	75	87	75	55	65	1,4	12
TBTMS0081924	63	19/24	75	87	75	55	65	1,4	12
TBTMS00748	75	24/0/24	75	87	75	55	65	1,6	12
TBTMS0071924	75	19/24	75	87	75	55	65	1,6	12
TBTMS01048	100	24/0/24	84	92	82	60	69	2,1	8
TBTMS0101924	100	19/24	84	92	82	60	69	2,1	8
TBTMS01348	150	24/0/24	96	98	92	68	71	3,0	8
TBTMS0131924	150	19/24	96	98	92	68	71	3,0	8
TBTMS01648	200	24/0/24	96	112	92	68	85	3,8	6
TBTMS0161924	200	19/24	96	112	92	68	85	3,8	6
TBTMS01948	250	24/0/24	120	102	112	80	70	4,4	6
TBTMS0191924	250	19/24	120	102	112	80	70	4,4	6
TBTMS02248	300	24/0/24	120	114	112	80	82	5,5	6
TBTMS0221924	300	19/24	120	114	112	80	82	5,5	6
TBTMS02548	350	24/0/24	120	114	112	80	82	5,5	6
TBTMS0251924	350	19/24	120	114	112	80	82	5,5	6
TBTMS02848	400	24/0/24	120	122	112	80	90	6,3	4
TBTMS0281924	400	19/24	120	122	112	80	90	6,3	4
TBTMS03148	500	24/0/24	120	134	112	80	102	7,4	4
TBTMS0311924	500	19/24	120	134	112	80	102	7,4	4
TBTMS03548	630	24/0/24	150	130	140	80	78	8,5	4
TBTMS0351924	630	19/24	150	130	140	80	78	8,5	4
TBTMS04048	800	24/0/24	150	150	140	80	96	10,4	4
TBTMS0401924	800	19/24	150	150	140	80	96	10,4	4
TBTMS04648	1000	24/0/24	150	150	140	80	96	10,8	4
TBTMS0461924	1000	19/24	150	150	140	80	96	10,8	4

TRASFORMATORI MONOFASE DI ISOLAMENTO UL "INSULATION SYSTEM" UL "INSULATION SYSTEM" SINGLE-PHASE ISOLATING TRANSFORMERS

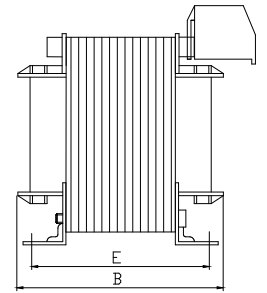
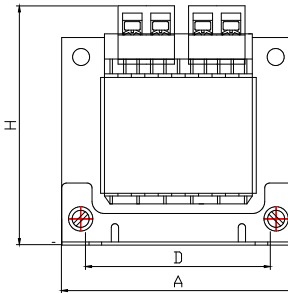
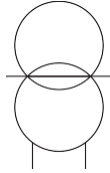

Trasformatore associato non resistente al cortocircuito
Trasformatore da incorporare in apparati elettrici specifici

*Associated transformer non-short-circuit proof
Transformer for special electric equipment*

Norme di riferimento: EN 61558-2-4; UL 1446
Frequenza: 50/60 Hz
Classe termica: F
Classe di isolamento: F
Tensione primaria: 0/230/400 V
Tensione secondaria: 55/0/55 V (0/55/110 V)
Tensione secondaria: 115/0/115 V (0/115/230 V)

*Reference standards: EN 61558-2-4; UL 1446
Frequency: 50/60 Hz
Thermal class: F
Insulation class: F
Primary voltage: 0/230/400 V
Secondary voltage: 55/0/55 V (0/55/110 V)
Secondary voltage: 115/0/115 V (0/115/230 V)*

CODICE PART NUMBER	POTENZA POWER [VA]	SECONDARIO SECONDARY [V]	Larghezza Width A [mm]	Profondità Depth B [mm]	Altezza Height H [mm]	Fissaggio Fixing D [mm]	Fissaggio Fixing E [mm]	Peso Weight [kg]	Imballo multiplo Multiple pack [pz - pcs]
TBTMI003110	30	55/0/55	75	72	75	55	50	1,0	12
TBTMI003230	30	115/0/115	75	72	75	55	50	1,0	12
TBTMI006110	50	55/0/55	75	78	75	55	56	1,3	12
TBTMI006230	50	115/0/115	75	78	75	55	56	1,3	12
TBTMI008110	63	55/0/55	75	87	75	55	65	1,4	12
TBTMI008230	63	115/0/115	75	87	75	55	65	1,4	12
TBTMI009110	75	55/0/55	75	87	75	55	65	1,6	12
TBTMI009230	75	115/0/115	75	87	75	55	65	1,6	12
TBTMI012110	100	55/0/55	84	92	82	60	69	2,1	8
TBTMI012230	100	115/0/115	84	92	82	60	69	2,1	8
TBTMI015110	150	55/0/55	96	98	92	68	71	3,0	8
TBTMI015230	150	115/0/115	96	98	92	68	71	3,0	8
TBTMI018110	200	55/0/55	96	112	92	68	85	3,8	6
TBTMI018230	200	115/0/115	96	112	92	68	85	3,8	6
TBTMI021110	250	55/0/55	120	102	112	80	70	4,4	6
TBTMI021230	250	115/0/115	120	102	112	80	70	4,4	6
TBTMI024110	300	55/0/55	120	114	112	80	82	5,5	6
TBTMI024230	300	115/0/115	120	114	112	80	82	5,5	6
TBTMI027110	350	55/0/55	120	114	112	80	82	5,6	6
TBTMI027230	350	115/0/115	120	114	112	80	82	5,6	6
TBTMI030110	400	55/0/55	120	122	112	80	90	6,3	4
TBTMI030230	400	115/0/115	120	122	112	80	90	6,3	4
TBTMI033110	500	55/0/55	120	134	112	80	102	7,3	4
TBTMI033230	500	115/0/115	120	134	112	80	102	7,3	4
TBTMI038110	630	55/0/55	150	130	140	80	78	8,5	4
TBTMI038230	630	115/0/115	150	130	140	80	78	8,5	4
TBTMI042110	800	55/0/55	150	150	140	80	96	10,4	4
TBTMI042230	800	115/0/115	150	150	140	80	96	10,4	4
TBTMI048110	1000	55/0/55	150	150	140	80	96	10,8	4
TBTMI048230	1000	115/0/115	150	150	140	80	96	10,8	4

TRASFORMATORI MONOFASE DI SICUREZZA SINGLE-PHASE SAFETY TRANSFORMERS

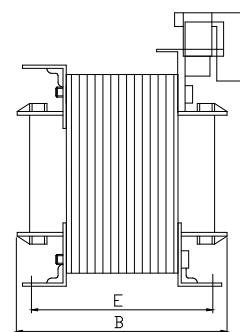
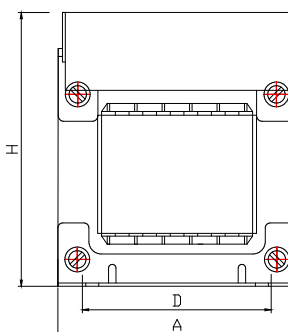
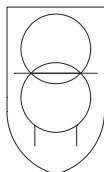

Trasformatore associato non resistente al cortocircuito
Trasformatore da incorporare in apparati elettrici specifici

*Associated transformer non-short-circuit proof
Transformer for special electric equipment*

Norme di riferimento: EN 61558-1, EN 61558-2-6
Frequenza: 50/60 Hz
Classe termica: B
Classe di isolamento: F
Tensione primaria: 0/230/400 V
Tensione secondaria: 12 V

*Reference standards: EN 61558-1, EN 61558-2-6
Frequency: 50/60 Hz
Thermal class: B
Insulation class: F
Primary voltage: 0/230/400 V
Secondary voltage: 12 V*

CODICE PART NUMBER	POTENZA POWER [VA]	Larghezza Width A [mm]	Profondità Depth B [mm]	Altezza Height H [mm]	Fissaggio Fixing D [mm]	Fissaggio Fixing E [mm]	Peso Weight [kg]
BTTMS00112	30	75	75	88	55	53	1,3
BTTMS00412	50	84	78	95	60	55	1,6
BTTMS00812	63	84	83	95	60	60	1,7
BTTMS00712	75	84	83	95	60	60	2,0
BTTMS01012	100	96	87	105	68	60	2,5
BTTMS01312	150	96	97	105	68	70	3,2
BTTMS01612	200	96	102	105	68	75	3,5
BTTMS01912	250	120	100	125	80	68	4,5
BTTMS02212	300	120	105	150	80	73	5,1
BTTMS02512	350	120	115	150	80	83	6,1
BTTMS02812	400	120	125	150	80	93	6,9
BTTMS03112	500	120	140	150	80	108	8,4
BTTMS03412	600	150	130	175	110	92	10,1
BTTMS03512	630	150	130	175	110	92	10,3
BTTMS04012	800	150	150	175	105	110	13,6
BTTMS04612	1000	150	170	175	105	130	16,5
BTTMS05512	1500	180	170	200	130	128	21,6
BTTMS06112	2000	192	194	210	160	144	28,8
BTTMS06712	2500	192	234	210	160	164	37,0
BTTMS07012	3000	240	190	225	210	136	37,5
BTTMS07612	4000	240	210	225	210	156	45,3
BTTMS08212	5000	240	240	225	210	186	55,7

TRASFORMATORI MONOFASE DI SICUREZZA SINGLE-PHASE SAFETY TRANSFORMERS

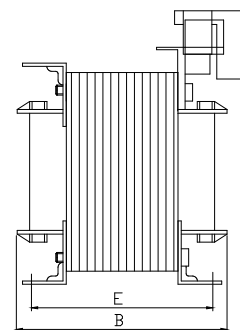
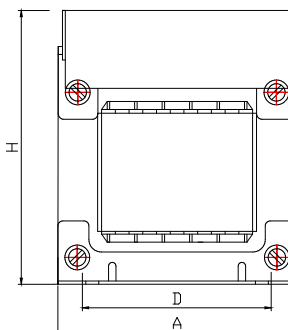
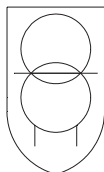

Trasformatore associato non resistente al cortocircuito
Trasformatore da incorporare in apparati elettrici specifici

*Associated transformer non-short-circuit proof
Transformer for special electric equipment*

Norme di riferimento: EN 61558-1, EN 61558-2-6

Reference standards: EN 61558-1, EN 61558-2-6

Frequenza: 50/60 Hz

Frequency: 50/60 Hz

Classe termica: B

Thermal class: B

Classe di isolamento: F

Insulation class: F

Tensione primaria: 0/230/400 V

Primary voltage: 0/230/400 V

Tensione secondaria: 24 V (12/0/12 V)

Secondary voltage: 24 V (12/0/12 V)

CODICE PART NUMBER	POTENZA POWER [VA]	Larghezza Width A [mm]	Profondità Depth B [mm]	Altezza Height H [mm]	Fissaggio Fixing D [mm]	Fissaggio Fixing E [mm]	Peso Weight [kg]
BTTMS00124	30	75	75	88	55	53	1,2
BTTMS00424	50	84	78	95	60	55	1,5
BTTMS00824	63	84	83	95	60	60	1,7
BTTMS00724	75	84	83	95	60	60	1,8
BTTMS01024	100	96	87	105	68	60	2,3
BTTMS01324	150	96	97	105	68	70	2,9
BTTMS01624	200	96	102	105	68	75	3,3
BTTMS01924	250	120	100	125	80	68	4,3
BTTMS02224	300	120	105	125	80	73	4,8
BTTMS02524	350	120	115	125	80	83	5,6
BTTMS02824	400	120	125	125	80	93	6,6
BTTMS03124	500	120	140	125	80	108	7,9
BTTMS03424	600	135	125	163	110	92	8,0
BTTMS03524	630	135	125	163	110	92	8,2
BTTMS04024	800	150	140	175	105	100	11,5
BTTMS04624	1000	150	160	175	105	120	14,0
BTTMS05524	1500	180	170	200	130	128	20,5
BTTMS06124	2000	192	194	210	160	144	27,9
BTTMS06724	2500	192	214	210	160	164	32,6
BTTMS07024	3000	192	234	210	160	184	37,3
BTTMS07624	4000	240	210	250	210	156	45,3
BTTMS08224	5000	240	230	250	210	176	52,7

TRASFORMATORI MONOFASE DI SICUREZZA SINGLE-PHASE SAFETY TRANSFORMERS

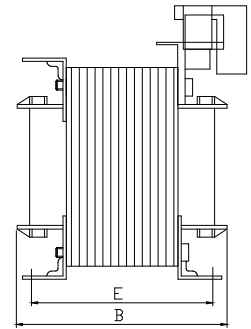
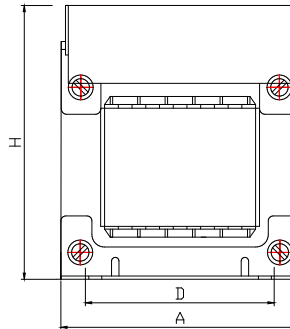
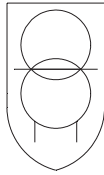

Trasformatore associato non resistente al cortocircuito
Trasformatore da incorporare in apparati elettrici specifici

*Associated transformer non-short-circuit proof
Transformer for special electric equipment*

Norme di riferimento: EN 61558-1, EN 61558-2-6

Reference standards: EN 61558-1, EN 61558-2-6

Frequenza: 50/60 Hz

Frequency: 50/60 Hz

Classe termica: B

Thermal class: B

Classe di isolamento: F

Insulation class: F

Tensione primaria: 0/230/400 V

Primary voltage: 0/230/400 V

Tensione secondaria: 0/19/24 V

Secondary voltage: 0/19/24 V

CODICE PART NUMBER	POTENZA POWER [VA]	Larghezza Width A [mm]	Profondità Depth B [mm]	Altezza Height H [mm]	Fissaggio Fixing D [mm]	Fissaggio Fixing E [mm]	Peso Weight [kg]
BTTMS0011924	30	75	75	88	55	53	1,2
BTTMS0041924	50	84	78	95	60	55	1,5
BTTMS0081924	63	84	83	95	60	60	1,7
BTTMS0071924	75	84	83	95	60	60	1,8
BTTMS0101924	100	96	87	105	68	60	2,3
BTTMS0131924	150	96	97	105	68	70	3,0
BTTMS0161924	200	96	102	105	68	75	3,3
BTTMS0191924	250	120	100	125	80	68	4,3
BTTMS0221924	300	120	105	125	80	73	4,8
BTTMS0251924	350	120	115	125	80	83	5,7
BTTMS0281924	400	120	125	125	80	93	6,6
BTTMS0311924	500	135	125	163	76	90	7,8
BTTMS0341924	600	135	125	163	110	92	8,0
BTTMS0351924	630	135	125	163	110	92	8,2
BTTMS0401924	800	150	140	200	105	100	11,3
BTTMS0461924	1000	150	170	200	105	130	15,3
BTTMS0551924	1500	180	170	225	130	128	20,5
BTTMS0611924	2000	192	184	235	160	144	25,9
BTTMS0671924	2500	192	214	235	160	164	30,6
BTTMS0701924	3000	192	234	235	160	184	37,2
BTTMS0761924	4000	240	210	275	210	156	45,3
BTTMS0821924	5000	240	240	275	210	186	55,7

TRASFORMATORI MONOFASE DI SICUREZZA SINGLE-PHASE SAFETY TRANSFORMERS

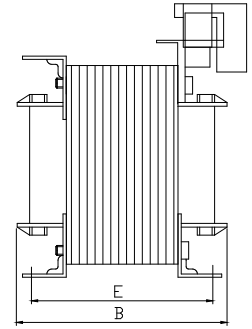
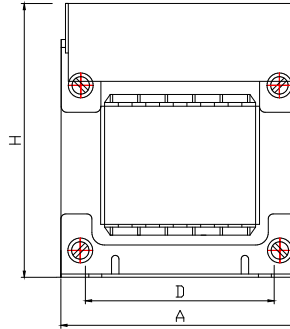
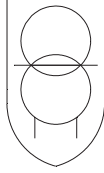

Trasformatore associato non resistente al cortocircuito
Trasformatore da incorporare in apparati elettrici specifici

*Associated transformer non-short-circuit proof
Transformer for special electric equipment*

Norme di riferimento: EN 61558-1, EN 61558-2-6

Reference standards: EN 61558-1, EN 61558-2-6

Frequenza: 50/60 Hz

Frequency: 50/60 Hz

Classe termica: B

Thermal class: B

Classe di isolamento: F

Insulation class: F

Tensione primaria: 0/230/400 V

Primary voltage: 0/230/400 V

Tensione secondaria: 48 V (24/0/24 V)

Secondary voltage: 48 V (24/0/24 V)

CODICE PART NUMBER	POTENZA POWER [VA]	Larghezza Width A [mm]	Profondità Depth B [mm]	Altezza Height H [mm]	Fissaggio Fixing D [mm]	Fissaggio Fixing E [mm]	Peso Weight [kg]
BTTMS00148	30	75	75	88	55	53	1,2
BTTMS00448	50	84	78	95	60	55	1,5
BTTMS00848	63	84	83	95	60	60	1,7
BTTMS00748	75	84	83	95	60	60	1,8
BTTMS01048	100	96	87	105	68	60	2,3
BTTMS01348	150	96	97	105	68	70	3,0
BTTMS01648	200	96	102	105	68	75	3,3
BTTMS01948	250	120	100	125	80	68	4,3
BTTMS02248	300	120	105	125	80	73	4,8
BTTMS02548	350	120	115	125	80	83	5,7
BTTMS02848	400	120	125	125	80	93	6,6
BTTMS03148	500	120	140	125	80	108	7,9
BTTMS03448	600	135	125	138	110	92	8,0
BTTMS03548	630	135	125	138	110	92	8,2
BTTMS04048	800	150	140	150	105	100	11,5
BTTMS04648	1000	150	160	150	105	120	14,0
BTTMS05548	1500	180	170	200	130	128	20,5
BTTMS06148	2000	192	184	210	160	144	26,1
BTTMS06748	2500	192	214	210	160	164	32,6
BTTMS07048	3000	192	190	250	160	184	37,5
BTTMS07648	4000	240	210	250	210	156	44,8
BTTMS08248	5000	240	240	250	210	186	56,1

TRASFORMATORI MONOFASE DI ISOLAMENTO SINGLE-PHASE ISOLATING TRANSFORMERS

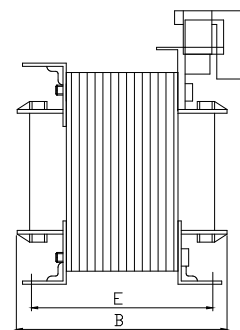
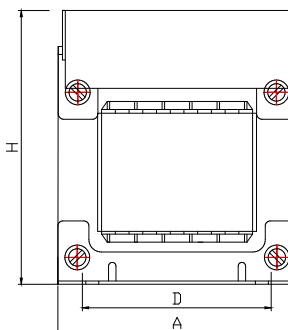
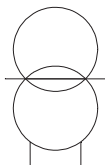

Trasformatore associato non resistente al cortocircuito
Trasformatore da incorporare in apparati elettrici specifici

*Associated transformer non-short-circuit proof
Transformer for special electric equipment*

Norme di riferimento: EN 61558-1, EN 61558-2-4

Reference standards: EN 61558-1, EN 61558-2-4

Frequenza: 50/60 Hz

Frequency: 50/60 Hz

Classe termica: B

Thermal class: B

Classe di isolamento: F

Insulation class: F

Tensione primaria: 0/230/400 V

Primary voltage: 0/230/400 V

Tensione secondaria: 110 V (55/0/55 V)

Secondary voltage: 110 V (55/0/55 V)

CODICE PART NUMBER	POTENZA POWER [VA]	Larghezza Width A [mm]	Profondità Depth B [mm]	Altezza Height H [mm]	Fissaggio Fixing D [mm]	Fissaggio Fixing E [mm]	Peso Weight [kg]
BTTMI003110	30	75	75	88	55	53	1,2
BTTMI006110	50	84	78	95	60	55	1,5
BTTMI008110	63	84	83	95	60	60	1,7
BTTMI009110	75	84	83	95	60	60	1,8
BTTMI012110	100	96	87	105	68	60	2,3
BTTMI015110	150	96	97	105	68	70	3,0
BTTMI018110	200	96	102	105	68	75	3,3
BTTMI021110	250	120	100	125	80	68	4,3
BTTMI024110	300	120	105	125	80	73	4,8
BTTMI027110	350	120	115	125	80	83	5,7
BTTMI030110	400	120	125	125	80	93	6,6
BTTMI033110	500	120	140	125	80	108	7,9
BTTMI036110	600	135	125	138	110	92	8,0
BTTMI038110	630	135	125	138	110	92	8,2
BTTMI042110	800	150	140	150	105	100	11,5
BTTMI048110	1000	150	160	150	105	130	14,0
BTTMI057110	1500	180	170	175	130	128	20,6
BTTMI063110	2000	192	184	210	160	144	26,1
BTTMI069110	2500	192	214	210	160	164	33,0
BTTMI072110	3000	192	234	210	160	184	37,3
BTTMI078110	4000	240	210	250	210	156	44,7
BTTMI084110	5000	240	220	250	210	166	49,3

TRASFORMATORI MONOFASE DI ISOLAMENTO SINGLE-PHASE ISOLATING TRANSFORMERS

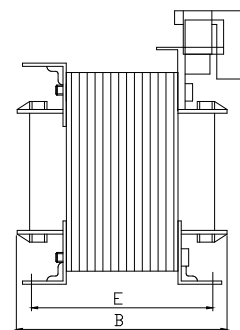
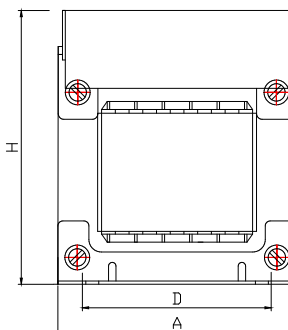
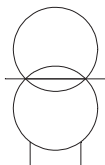

Trasformatore associato non resistente al cortocircuito
Trasformatore da incorporare in apparati elettrici specifici

*Associated transformer non-short-circuit proof
Transformer for special electric equipment*

Norme di riferimento: EN 61558-1, EN 61558-2-4

Frequenza: 50/60 Hz

Classe termica: B

Classe di isolamento: F

Tensione primaria: 0/230/400 V

Tensione secondaria: 230 V (115/0/115 V)

Reference standards: EN 61558-1, EN 61558-2-4

Frequency: 50/60 Hz

Thermal class: B

Insulation class: F

Primary voltage: 0/230/400 V

Secondary voltage: 230 V (115/0/115 V)

CODICE PART NUMBER	POTENZA POWER [VA]	Larghezza Width A [mm]	Profondità Depth B [mm]	Altezza Height H [mm]	Fissaggio Fixing D [mm]	Fissaggio Fixing E [mm]	Peso Weight [kg]
BTTMI003230	30	75	75	88	55	53	1,2
BTTMI006230	50	84	78	95	60	55	1,5
BTTMI008230	63	84	83	95	60	60	1,7
BTTMI009230	75	84	83	95	60	60	1,8
BTTMI012230	100	96	87	105	68	60	2,3
BTTMI015230	150	96	97	105	68	70	3,0
BTTMI018230	200	96	102	105	68	75	3,3
BTTMI021230	250	120	100	125	80	68	4,3
BTTMI024230	300	120	105	125	80	73	4,9
BTTMI027230	350	120	115	125	80	83	5,7
BTTMI030230	400	120	125	125	80	93	6,6
BTTMI033230	500	120	140	125	80	108	7,9
BTTMI036230	600	135	125	138	110	92	8,0
BTTMI038230	630	135	125	138	110	92	8,2
BTTMI042230	800	150	140	150	105	100	11,5
BTTMI048230	1000	150	160	150	105	130	14,0
BTTMI057230	1500	180	170	175	130	128	20,7
BTTMI063230	2000	192	184	185	160	144	25,8
BTTMI069230	2500	192	214	185	160	164	33,2
BTTMI072230	3000	192	234	185	160	184	38,2
BTTMI078230	4000	240	220	250	210	166	48,9
BTTMI084230	5000	240	220	250	210	166	49,0

TRASFORMATORI MONOFASE "UL RECOGNIZED" "UL RECOGNIZED" SINGLE-PHASE TRANSFORMERS

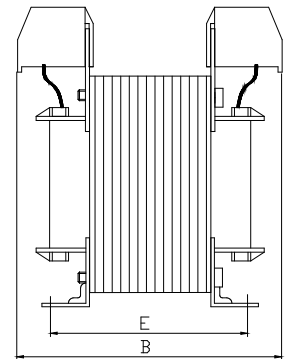
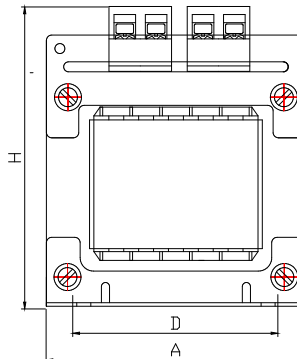
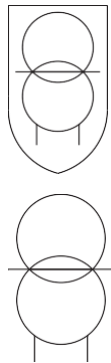

Trasformatore associato non resistente al cortocircuito
Trasformatore da incorporare in apparati elettrici specifici

*Associated transformer non-short-circuit proof
Transformer for special electric equipment*

Norme di riferimento: UL5085 e CSA C22.2 No 66
Frequenza: 50/60 Hz
Classe termica: A
Classe di isolamento: F
Temperatura ambiente: 40 °C

*Reference standards: UL5085 and CSA C22.2 No 66
Frequency: 50/60 Hz
Thermal class: A
Insulation class: F
Ambient temperature: 40 °C*

Trasformatore di tipo "Industrial control" adatto anche ad essere installato in quadri elettrici costruiti in accordo alla norma UL 508A "Standard for industrial control panels".

Industrial control transformer suitable for installation in electric equipment manufactured according to UL 508A "Standard for industrial control panels".

Le lettere YY presenti nella codifica del trasformatore sono sostituite in fase d'ordine da un numero di due o tre cifre e seguite dalla dicitura UL o PF.UL. I numeri assegnati identificano univocamente il trasformatore ordinato.

YY letters in transformers part number are changed with two or three digit numbers, followed by UL or PF.UL. Those numbers will identify customer finished product part number.

Trasformatore personalizzabile con diverse tensioni e prese di regolazione sia al primario che al secondario.

Transformer suitable to be customized with different rated voltages and regulation taps both at primary and secondary end.

CODICE PART NUMBER	POTENZA POWER [VA]	Larghezza Width A [mm]	Profondità Depth B [mm]	Altezza Height H [mm]	Fissaggio Fixing D [mm]	Fissaggio Fixing E [mm]	Peso Weight [kg]
TM.0030.YY.UL	30	75	80	83	55	58	1,4
TM.0050.YY.UL	50	84	86	90	60	60	1,8
TM.0075.YY.UL	75	84	88	90	60	65	2,1
TM.0100.YY.UL	100	84	93	90	60	70	2,4
TM.0150.YY.UL	150	108	106	110	75	79	4,2
TM.0200.YY.UL	200	120	100	120	80	68	4,5
TM.0250.YY.UL	250	120	120	120	80	88	6,2
TM.0300.YY.UL	300	120	130	120	80	98	7,2
TM.0400.YY.UL	400	120	140	120	80	108	8,5
TM.0500.YY.UL	500	150	130	145	105	90	10,5
TM.0600.YY.UL	600	150	140	145	105	100	11,9
TM.0700.YY.UL	700	150	160	145	105	120	14,5
TM.1000.YY.UL	1000	192	184	180	145	139	24,8
TM.1500.YY.UL	1500	192	204	180	145	159	30,4
TM.2000.YY.UL	2000	240	200	220	210	146	40,6

TRASFORMATORI MONOFASE "UL RECOGNIZED" "UL RECOGNIZED" SINGLE-PHASE TRANSFORMERS

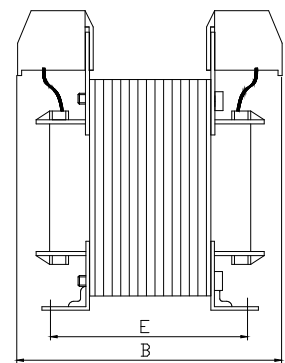
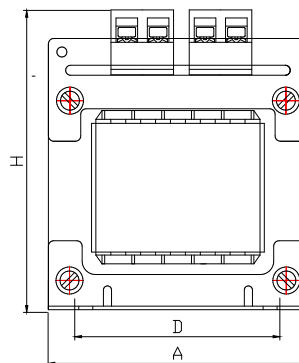
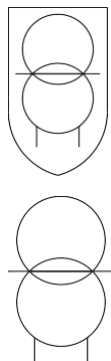
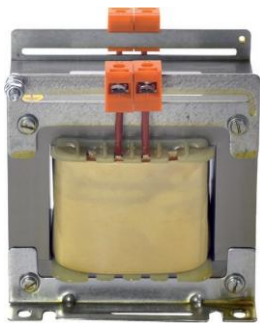

Trasformatore associato non resistente al cortocircuito
Trasformatore da incorporare in apparati elettrici specifici

*Associated transformer non-short-circuit proof
Transformer for special electric equipment*

Norme di riferimento: UL5085 e CSA C22.2 No 66
Frequenza: 50/60 Hz
Classe termica e d'isolamento: F
Temperatura ambiente: 40 °C

*Reference standards: UL5085 and CSA C22.2 No 66
Frequency: 50/60 Hz
Thermal & insulation class: F
Ambient temperature: 40 °C*

Trasformatore "Industrial control" adatto anche ad essere installato in quadri elettrici costruiti in accordo alla norma UL 508A "Standard for industrial control panels".

Industrial control transformer suitable for installation in electric equipment manufactured according to UL 508A "Standard for industrial control panels".

CODICE PART NUMBER	POTENZA POWER [VA]	Larghezza Width A [mm]	Profondità Depth B [mm]	Altezza Height H [mm]	Fissaggio Fixing D [mm]	Fissaggio Fixing E [mm]	Peso Weight [kg]
TMF2.00030.XX.UL	30	75	75	88	55	53	1,2
TMF2.00040.XX.UL	40	84	78	95	60	55	1,4
TMF2.00050.XX.UL	50	84	78	95	60	55	1,5
TMF2.00063.XX.UL	63	84	83	95	60	60	1,7
TMF2.00075.XX.UL	75	84	83	95	60	60	1,8
TMF2.00080.XX.UL	80	96	84	105	68	57	2,1
TMF2.00100.XX.UL	100	96	87	105	68	60	2,3
TMF2.00150.XX.UL	150	96	97	105	68	70	2,9
TMF2.00160.XX.UL	160	96	102	105	68	70	3,2
TMF2.00200.XX.UL	200	108	106	115	75	79	4,0
TMF2.00250.XX.UL	250	120	100	125	80	68	4,6
TMF2.00300.XX.UL	300	120	110	125	80	78	5,3
TMF2.00320.XX.UL	320	120	115	125	80	84	5,6
TMF2.00400.XX.UL	400	120	125	125	80	93	6,6
TMF2.00500.XX.UL	500	135	125	138	110	92	7,9
TMF2.00600.XX.UL	600	150	130	150	105	90	9,8
TMF2.00630.XX.UL	630	150	140	150	105	100	10,6
TMF2.00700.XX.UL	700	150	150	150	105	110	11,6
TMF2.00800.XX.UL	800	150	160	150	105	120	13,8
TMF2.01000.XX.UL	1000	180	140	175	130	98	14,6
TMF2.01200.XX.UL	1200	180	150	175	130	108	16,5
TMF2.01300.XX.UL	1300	180	160	175	130	118	18,5
TMF2.01500.XX.UL	1500	180	170	175	130	128	20,7
TMF2.01600.XX.UL	1600	195	174	185	145	129	24,0
TMF2.02000.XX.UL	2000	195	184	185	145	139	25,9
TMF2.02200.XX.UL	2200	195	204	185	145	159	30,1
TMF2.02500.XX.UL	2500	195	214	185	145	169	33,0
TMF2.03000.XX.UL	3000	195	234	185	145	189	37,6
TMF2.03200.XX.UL	3200	240	200	225	210	146	40,1
TMF2.04000.XX.UL	4000	240	220	225	210	166	48,9
TMF2.05000.XX.UL	5000	240	180	350	205	144	45,9
TMF2.06000.XX.UL	6000	240	190	350	205	154	50,4
TMF2.06300.XX.UL	6300	280	180	400	234	136	55,2
TMF2.07000.XX.UL	7000	280	190	400	234	146	62,0
TMF2.10000.XX.UL	10000	280	220	400	234	176	80,9
TMF2.11000.XX.UL	11000	280	230	400	234	186	87,7
TMF2.13000.XX.UL	13000	280	250	400	234	206	98,5

TRASFORMATORI MONOFASE “UL RECOGNIZED” “UL RECOGNIZED” SINGLE-PHASE TRANSFORMERS

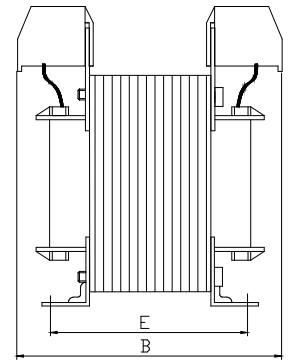
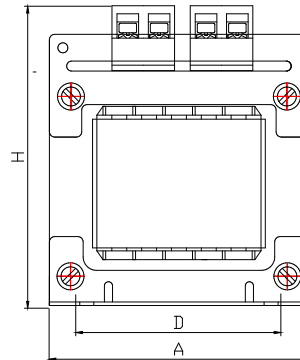
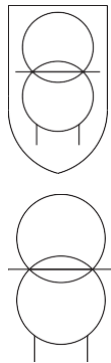
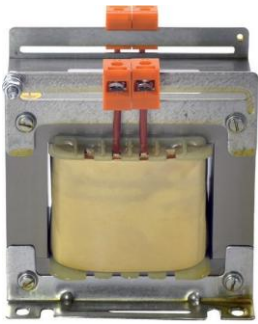

Trasformatore associato non resistente al cortocircuito
Trasformatore da incorporare in apparati elettrici specifici

*Associated transformer non-short-circuit proof
Transformer for special electric equipment*

Norme di riferimento: UL5085 e CSA C22.2 No 66
Frequenza: 50/60 Hz
Classe termica e d'isolamento: F
Temperatura ambiente: 40 °C

*Reference standards: UL5085 and CSA C22.2 No 66
Frequency: 50/60 Hz
Thermal & insulation class: F
Ambient temperature: 40 °C*

Trasformatore “Industrial control” adatto anche ad essere installato in quadri elettrici costruiti in accordo alla norma UL 508A “Standard for industrial control panels”.

Industrial control transformer suitable for installation in electric equipment manufactured according to UL 508A “Standard for industrial control panels”.

CODICE PART NUMBER	POTENZA POWER [VA]	Larghezza Width A [mm]	Profondità Depth B [mm]	Altezza Height H [mm]	Fissaggio Fixing D [mm]	Fissaggio Fixing E [mm]	Peso Weight [kg]
TMF3.00600.XX.UL	600	150	160	150	105	120	9,8
TMF3.00630.XX.UL	630	150	160	150	105	120	10,6
TMF3.00700.XX.UL	700	180	140	175	130	98	14,6
TMF3.00800.XX.UL	800	180	160	175	130	118	18,5
TMF3.01000.XX.UL	1000	180	140	175	130	98	14,6
TMF3.01200.XX.UL	1200	180	150	175	130	108	16,5
TMF3.01300.XX.UL	1300	180	160	175	130	118	18,5
TMF3.01500.XX.UL	1500	180	170	175	130	128	20,7
TMF3.01600.XX.UL	1600	180	170	175	130	128	23,8
TMF3.02000.XX.UL	2000	195	184	185	145	139	25,9
TMF3.02200.XX.UL	2200	195	204	185	145	159	30,1
TMF3.02500.XX.UL	2500	195	214	185	145	169	33,0
TMF3.03000.XX.UL	3000	195	234	185	145	189	37,6
TMF3.03200.XX.UL	3200	240	200	225	210	146	40,1
TMF3.04000.XX.UL	4000	240	220	225	210	166	48,9
TMF3.05000.XX.UL	5000	240	180	350	205	144	45,9
TMF3.06000.XX.UL	6000	240	190	350	205	154	50,4
TMF3.06300.XX.UL	6300	280	180	400	234	136	55,2
TMF3.07000.XX.UL	7000	280	190	400	234	146	62,0
TMF3.10000.XX.UL	10000	280	220	400	234	176	80,9
TMF3.11000.XX.UL	11000	280	230	400	234	186	87,7
TMF3.13000.XX.UL	13000	280	250	400	234	206	92,0

TRASFORMATORI MONOFASE "UL LISTED" "UL LISTED" SINGLE-PHASE TRANSFORMERS

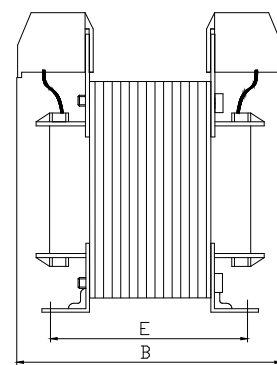
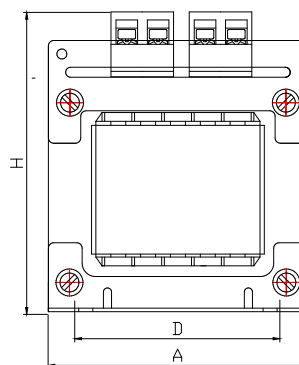
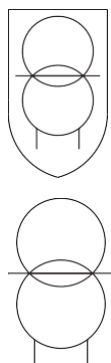
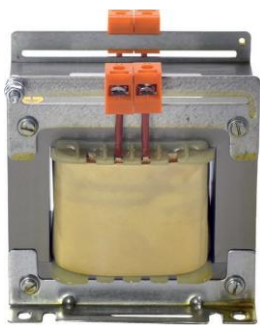

Trasformatore associato non resistente al cortocircuito
Trasformatore da incorporare in apparati elettrici specifici

*Associated transformer non-short-circuit proof
Transformer for special electric equipment*

Norme di riferimento: UL5085 e CSA C22.2 No 66
Frequenza: 50/60 Hz
Classe termica e d'isolamento: F
Temperatura ambiente: 40 °C

*Reference standards: UL5085 and CSA C22.2 No 66
Frequency: 50/60 Hz
Thermal & insulation class: F
Ambient temperature: 40 °C*

Trasformatore "Industrial control" adatto anche ad essere installato in quadri elettrici costruiti in accordo alla norma UL 508A "Standard for industrial control panels".

Industrial control transformer suitable for installation in electric equipment manufactured according to UL 508A "Standard for industrial control panels".

CODICE PART NUMBER	POTENZA POWER [VA]	Larghezza Width A [mm]	Profondità Depth B [mm]	Altezza Height H [mm]	Fissaggio Fixing D [mm]	Fissaggio Fixing E [mm]	Peso Weight [kg]
TML2.00030.XX.UL	30	75	75	88	55	53	1,2
TML2.00040.XX.UL	40	84	78	95	60	55	1,4
TML2.00050.XX.UL	50	84	78	95	60	55	1,5
TML2.00063.XX.UL	63	84	83	95	60	60	1,7
TML2.00075.XX.UL	75	84	83	95	60	60	1,8
TML2.00080.XX.UL	80	96	84	105	68	57	2,1
TML2.00100.XX.UL	100	96	87	105	68	60	2,3
TML2.00150.XX.UL	150	96	97	105	68	70	2,9
TML2.00160.XX.UL	160	96	102	105	68	70	3,2
TML2.00200.XX.UL	200	108	106	115	75	79	4,0
TML2.00250.XX.UL	250	120	100	125	80	68	4,6
TML2.00300.XX.UL	300	120	110	125	80	78	5,3
TML2.00320.XX.UL	320	120	115	125	80	84	5,6
TML2.00400.XX.UL	400	120	125	125	80	93	6,6
TML2.00500.XX.UL	500	135	125	138	110	92	7,9
TML2.00600.XX.UL	600	150	130	150	105	90	9,8
TML2.00630.XX.UL	630	150	140	150	105	100	10,6
TML2.00700.XX.UL	700	150	150	150	105	110	11,6
TML2.00800.XX.UL	800	150	160	150	105	120	13,8
TML2.01000.XX.UL	1000	180	140	175	130	98	14,6
TML2.01200.XX.UL	1200	180	150	175	130	108	16,5
TML2.01300.XX.UL	1300	180	160	175	130	118	18,5
TML2.01500.XX.UL	1500	180	170	175	130	128	20,7
TML2.01600.XX.UL	1600	195	174	185	145	129	24,0
TML2.02000.XX.UL	2000	195	184	185	145	139	25,9
TML2.02200.XX.UL	2200	195	204	185	145	159	30,1
TML2.02500.XX.UL	2500	195	214	185	145	169	33,0
TML2.03000.XX.UL	3000	195	234	185	145	189	37,6
TML2.03200.XX.UL	3200	240	200	225	210	146	40,1
TML2.04000.XX.UL	4000	240	220	225	210	166	48,9
TML2.05000.XX.UL	5000	240	180	350	205	144	45,9

TRASFORMATORI MONOFASE "UL LISTED" "UL LISTED" SINGLE-PHASE TRANSFORMERS

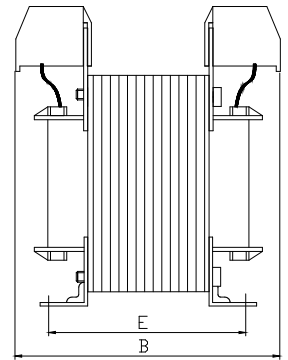
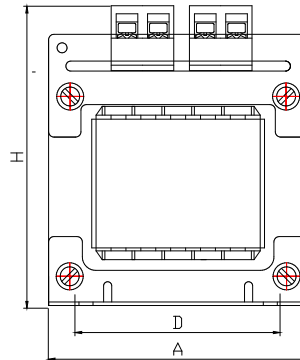
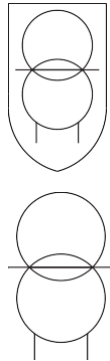
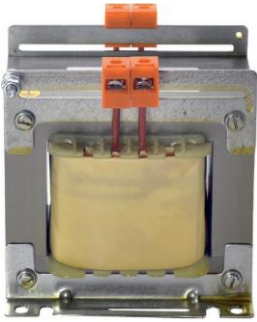

Trasformatore associato non resistente al cortocircuito
Trasformatore da incorporare in apparati elettrici specifici

*Associated transformer non-short-circuit proof
Transformer for special electric equipment*

Norme di riferimento: UL5085 e CSA C22.2 No 66
Frequenza: 50/60 Hz
Classe termica e d'isolamento: F
Temperatura ambiente: 40 °C

*Reference standards: UL5085 and CSA C22.2 No 66
Frequency: 50/60 Hz
Thermal & insulation class: F
Ambient temperature: 40 °C*

Trasformatore "Industrial control" adatto anche ad essere installato in quadri elettrici costruiti in accordo alla norma UL 508A "Standard for industrial control panels".

Industrial control transformer suitable for installation in electric equipment manufactured according to UL 508A "Standard for industrial control panels".

CODICE PART NUMBER	POTENZA POWER [VA]	Larghezza Width A [mm]	Profondità Depth B [mm]	Altezza Height H [mm]	Fissaggio Fixing D [mm]	Fissaggio Fixing E [mm]	Peso Weight [kg]
TMF3.00600.XX.UL	600	150	160	150	105	120	9,8
TMF3.00630.XX.UL	630	150	160	150	105	120	10,6
TMF3.00700.XX.UL	700	180	140	175	130	98	14,6
TMF3.00800.XX.UL	800	180	160	175	130	118	18,5
TMF3.01000.XX.UL	1000	180	140	175	130	98	14,6
TMF3.01200.XX.UL	1200	180	150	175	130	108	16,5
TMF3.01300.XX.UL	1300	180	160	175	130	118	18,5
TMF3.01500.XX.UL	1500	180	170	175	130	128	20,7
TMF3.01600.XX.UL	1600	180	170	175	130	128	23,8
TMF3.02000.XX.UL	2000	195	184	185	145	139	25,9
TMF3.02200.XX.UL	2200	195	204	185	145	159	30,1
TMF3.02500.XX.UL	2500	195	214	185	145	169	33,0
TMF3.03000.XX.UL	3000	195	234	185	145	189	37,6
TMF3.03200.XX.UL	3200	240	200	225	210	146	40,1
TMF3.04000.XX.UL	4000	240	220	225	210	166	48,9
TMF3.05000.XX.UL	5000	240	180	350	205	144	45,9

TRASFORMATORI MONOFASE OMOLOGATI ENEC ENEC APPROVED SINGLE-PHASE TRANSFORMERS

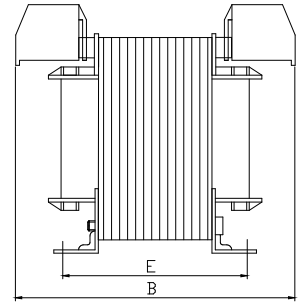
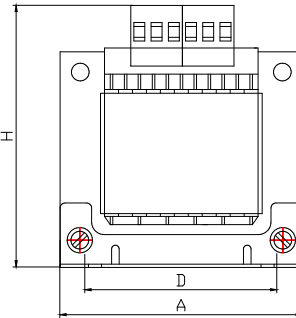
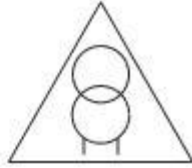
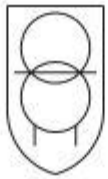

In particolari ambiti produttivi, come quello della produzione e imballaggio degli alimenti, è necessario mantenere elevati standard di sicurezza elettrica. Per questa ragione, la certificazione ENEC viene chiesta a garanzia della marcatura CE.

Norme di riferimento: EN 61558-2-2, EN 61558-2-4, EN 61558-2-6

Frequenza: 50/60 Hz

Classe termica: F

Classe di isolamento: F

Temperatura ambiente: 40 °C

Certificato n° 81-137798 per i trasformatori di comando
Certificato n° 81-139269 per i trasformatori di isolamento
Certificato n° 81-137801 per i trasformatori di sicurezza

Le lettere XX presenti nella codifica del trasformatore sono sostituite in fase d'ordine da un numero di due cifre seguito dalla sigla EN. I numeri assegnati identificano univocamente il trasformatore ordinato.

Trasformatore personalizzabile con diverse tensioni e prese di regolazione sia al primario che al secondario.

In special production areas such as in food packaging and production, it is necessary to assure important electrical safety standards. For this reason, ENEC certification is required to grant CE marking.

Reference standards: EN 61558-2-2, EN 61558-2-4, EN 61558-2-6

Frequency: 50/60 Hz

Thermal class: F

Insulation class: F

Ambient temperature: 40 °C

*Certificate n° 81-137798 for control transformers
Certificate n° 81-139269 for isolating transformers
Certificate n° 81-137801 for safety transformers*

XX letters in transformers part number are changed with a two digit number, followed by EN. That number will identify customer finished product part number.

Transformer suitable to be customized with different rated voltages and regulation taps both at primary and secondary windings.

CODICE PART NUMBER	POTENZA POWER [VA]	POTENZA ISTANTANEA INRUSH POWER [VA]	Larghezza Width A [mm]	Profondità Depth B [mm]	Altezza Height H [mm]	Fissaggio Fixing D [mm]	Fissaggio Fixing E [mm]	Peso Weight [kg]
TM.0030.XX.EN	30	45	75	58	80	55	45	1,0
TM.0050.XX.EN	50	90	75	71	80	55	60	1,3
TM.0063.XX.EN	63	110	84	65	90	60	54	1,5
TM.0080.XX.EN	80	150	84	76	90	60	68	1,7
TM.0100.XX.EN	100	220	84	76	90	60	68	2,1
TM.0150.XX.EN	150	300	96	83	103	68	70	3,0
TM.0200.XX.EN	200	400	96	95	103	68	84	3,8
TM.0250.XX.EN	250	520	122	85	125	100	70	4,4
TM.0300.XX.EN	300	650	122	93	125	100	80	5,5
TM.0400.XX.EN	400	850	122	105	125	100	90	6,3
TM.0500.XX.EN	500	1100	122	115	125	100	100	7,3
TM.0630.XX.EN	630	1400	155	115	150	125	86	8,3
TM.0700.XX.EN	700	1800	155	123	150	125	96	9,5
TM.0800.XX.EN	800	2300	155	133	150	125	106	11,0
TM.1000.XX.EN	1000	2900	155	148	150	125	126	14,0
TM.1300.XX.EN	1300	3500	186	156	185	155	116	18,0
TM.1600.XX.EN	1600	4200	198	172	185	168	126	23,0
TM.2000.XX.EN	2000	5000	198	190	194	168	146	26,0

TRASFORMATORI MONOFASE OMOLOGATI ATEX ATEX APPROVED SINGLE-PHASE TRANSFORMERS

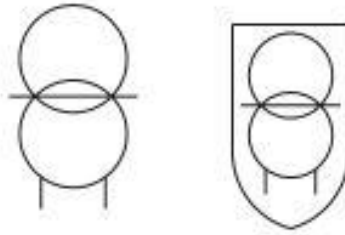
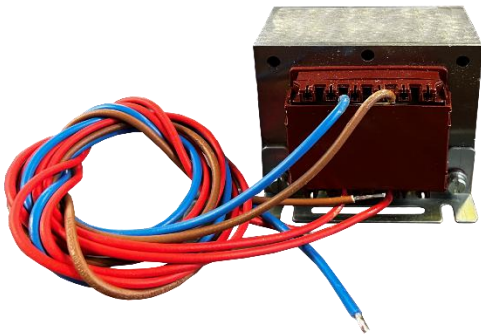

Trasformatore associato non resistente al cortocircuito
Trasformatore da incorporare in apparati elettrici specifici

Norme di riferimento: EN 61558 / EN 60079
Frequenza: 50/60 Hz
Classe termica e d'isolamento: B / F
Temperatura ambiente: 60 °C

*Associated transformer non-short-circuit proof
Transformer for special electric equipment*

*Reference standards: EN 61558 / EN 60079
Frequency: 50/60 Hz
Thermal & insulation class: B / F
Ambient temperature: 60 °C*

36

Su esplicita richiesta, possiamo fornire trasformatori certificati per zona ATEX-gas, uscite su cavi.

La stringa delle indicazioni è: II 3G Ex ec IIC T3 Gc
Questo significa che:

- II – può essere installato solo *in superficie* (non è idoneo all'utilizzo *in miniera*)
- 3G – può essere utilizzato in zona "3", laddove è possibile che si generino miscele potenzialmente esplosive per la presenza di gas (non polveri)
- Ex – generica indicazione "pericolo di esplosione"
- ec – indica il modo di protezione "e" (*a protezione aumentata*)
- IIC - funzionamento previsto in presenza di miscele di gas di tipo "IIC", e per tutti i tipi di gas aventi minor grado di pericolo
- T3 - massima temperatura superficiale < 200 °C
- Gc – ripete l'informazione 3G (vedi sopra)

Questi apparecchi non possono essere utilizzati:

- in miniera
- in presenza di miscele esplosive per la presenza di polveri
- in zona "0", "1", "20", "21", "22"

On request, we can supply ATEX-gas certificated machines (transformers, autotransformer, inductances) with connections on cables.

Further indications are: II 3G Ex ec IIC T3 Gc
It means:

- II – it can be used only in surface environment (unfit for mining)
- 3G – it can be used in zone "3", where it is possible to find explosive atmospheres because of gases (not dust)
- Ex – general reference "Explosive atmosphere"
- ec – protection mode used "e" (*increased safety*)
- IIC – it can work with gas type up to IIC
- T3 - max surface temperature < 200 °C
- Gc – same information as 3G (see above)

This device cannot be installed:

- In mines
- In explosive atmosphere caused by dust
- In zones "0", "1", "20", "21", "22"

TRASFORMATORI MONOFASE PER GUIDA DIN DIN RAIL CASE SINGLE-PHASE TRANSFORMERS

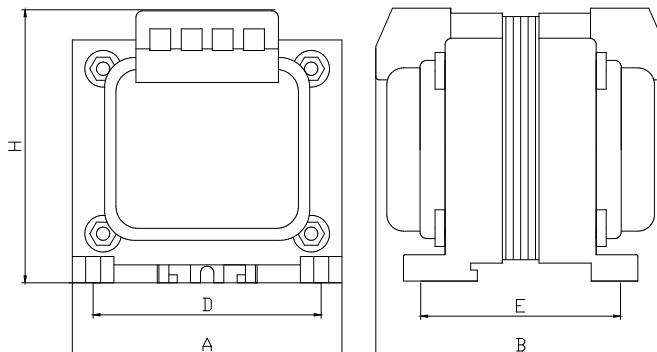
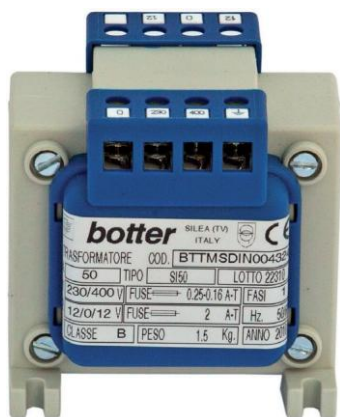

Fino a potenza 250 VA

Up to 250 VA power

37

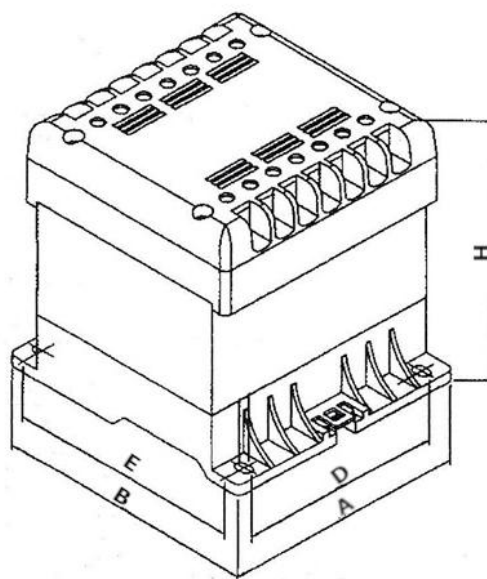

300 VA e superiori

300 VA and major

TRASFORMATORI MONOFASE DI SICUREZZA PER GUIDA DIN DIN RAIL CASE SINGLE-PHASE SAFETY TRANSFORMERS



Trasformatore associato non resistente al cortocircuito
Trasformatore da incorporare in apparati elettrici specifici con fissaggio su guida DIN (possibile fissaggio anche a mezzo viti)

*Associated transformer non-short-circuit proof
Transformer for special electric equipment, provided with support for DIN rail coupling (transformer can also be fixed by screws)*

Norme di riferimento: EN 61558-2-6

Trasformatore protetto in classe I

Grado di protezione: IP20

Frequenza: 50/60 Hz

Tensione primaria: 0/230/400 V

Tensione secondaria: 12 V

Tensione secondaria: 24 V (12/0/12 V)

Tensione secondaria: 48 V (24/0/24 V)

Reference standards: EN 61558-2-6

Protection class I transformer

Protection degree: IP20

Frequency: 50/60Hz

Primary voltage: 0/230/400 V

Secondary voltage: 12 V

Secondary voltage: 24 V (12/0/12 V)

Secondary voltage: 48 V (24/0/48 V)

CODICE PART NUMBER	POTENZA POWER [VA]	SECONDARIO SECONDARY [V]	Larghezza Width A [mm]	Profondità Depth B [mm]	Altezza Height H [mm]	Fissaggio Fixing D [mm]	Fissaggio Fixing E [mm]	Peso Weight [kg]
BTTMSDIN001312	30	12	81	75	83	68	51	1,2
BTTMSDIN001324	30	12/0/12	81	75	83	68	51	1,2
BTTMSDIN001348	30	24/0/24	81	75	83	68	51	1,2
BTTMSDIN004312	50	12	81	75	83	68	51	1,2
BTTMSDIN004324	50	12/0/12	81	75	83	68	51	1,2
BTTMSDIN004348	50	24/0/24	81	75	83	68	51	1,2
BTTMSDIN008312	63	12	81	85	83	68	61	1,5
BTTMSDIN008324	63	12/0/12	81	85	83	68	61	1,5
BTTMSDIN008348	63	24/0/24	81	85	83	68	61	1,5
BTTMSDIN007312	75	12	81	85	83	68	61	1,6
BTTMSDIN007324	75	12/0/12	81	85	83	68	61	1,6
BTTMSDIN007348	75	24/0/24	81	85	83	68	61	1,6
BTTMSDIN010312	100	12	102	90	101	86	62	2,3
BTTMSDIN010324	100	12/0/12	102	90	101	86	62	2,3
BTTMSDIN010348	100	24/0/24	102	90	101	86	62	2,3
BTTMSDIN013312	150	12	102	95	101	86	66	2,7
BTTMSDIN013324	150	12/0/12	102	95	101	86	66	2,7
BTTMSDIN013348	150	24/0/24	102	95	101	86	66	2,7
BTTMSDIN016312	200	12	102	105	101	86	76	3,3
BTTMSDIN016324	200	12/0/12	102	105	101	86	76	3,3
BTTMSDIN016348	200	24/0/24	102	105	101	86	76	3,3
BTTMSDIN019312	250	12	102	115	101	86	87	3,9
BTTMSDIN019324	250	12/0/12	102	115	101	86	87	3,9
BTTMSDIN019348	250	24/0/24	102	115	101	86	87	3,8
BTTMSDIN022312	300	12	126	136	117	96	121	4,3
BTTMSDIN022324	300	12/0/12	126	136	117	96	121	4,3
BTTMSDIN022348	300	24/0/24	126	136	117	96	121	4,3
BTTMSDIN025312	350	12	126	136	117	96	121	4,3
BTTMSDIN025324	350	12/0/12	126	136	117	96	121	4,3
BTTMSDIN025348	350	24/0/24	126	136	117	96	121	4,3
BTTMSDIN028312	400	12	126	136	127	96	121	5,2
BTTMSDIN028324	400	12/0/12	126	136	127	96	121	5,2
BTTMSDIN028348	400	24/0/24	126	136	127	96	121	5,2
BTTMSDIN031312	500	12	126	136	127	96	121	5,3
BTTMSDIN031324	500	12/0/12	126	136	127	96	121	5,3
BTTMSDIN031348	500	24/0/24	126	136	127	96	121	5,3

TRASFORMATORI MONOFASE DI ISOLAMENTO PER GUIDA DIN DIN RAIL CASE SINGLE-PHASE ISOLATING TRANSFORMERS



Trasformatore associato non resistente al cortocircuito
Trasformatore da incorporare in apparati elettrici specifici
con fissaggio su guida DIN (oppure a mezzo viti)

*Associated transformer non-short-circuit proof
Transformer for special electric equipment, provided with
support for DIN rail coupling (or fixed by screws)*

Norme di riferimento: EN 61558-2-4

Reference standards: EN 61558-2-4

Trasformatore protetto in classe I

Protection class I transformer

Grado di protezione: IP20

Protection degree: IP20

Frequenza: 50/60 Hz

Frequency: 50/60 Hz

Tensione primaria: 0/230/400 V

Primary voltage: 0/230/400 V

Tensione secondaria: 110 V (55/0/55 V)

Secondary voltage: 110 V (55/0/55 V)

Tensione secondaria: 230 V (115/0/115 V)

Secondary voltage: 230 V (115/0/115 V)

CODICE PART NUMBER	POTENZA POWER [VA]	SECONDARIO SECONDARY [V]	Larghezza Width A [mm]	Profondità Depth B [mm]	Altezza Height H [mm]	Fissaggio Fixing D [mm]	Fissaggio Fixing E [mm]	Peso Weight [kg]
BTTMIDIN003311	30	55/0/55	81	75	83	68	51	1,2
BTTMIDIN003323	30	115/0/115	81	75	83	68	51	1,2
BTTMIDIN006311	50	55/0/55	81	75	83	68	51	1,2
BTTMIDIN006323	50	115/0/115	81	75	83	68	51	1,2
BTTMIDIN008311	63	55/0/55	81	85	83	68	61	1,5
BTTMIDIN008323	63	115/0/115	81	85	83	68	61	1,5
BTTMIDIN009311	75	55/0/55	81	85	83	68	61	1,6
BTTMIDIN009323	75	115/0/115	81	85	83	68	61	1,6
BTTMIDIN012311	100	55/0/55	102	90	101	86	62	2,3
BTTMIDIN012323	100	115/0/115	102	90	101	86	62	2,3
BTTMIDIN015311	150	55/0/55	102	95	101	86	66	2,7
BTTMIDIN015323	150	115/0/115	102	95	101	86	66	2,7
BTTMIDIN018311	200	55/0/55	102	105	101	86	76	3,3
BTTMIDIN018323	200	115/0/115	102	105	101	86	76	3,3
BTTMIDIN021311	250	55/0/55	102	115	101	86	87	3,9
BTTMIDIN021323	250	115/0/115	102	115	101	86	87	3,8
BTTMIDIN024311	300	55/0/55	126	136	117	96	121	4,3
BTTMIDIN024323	300	115/0/115	126	136	117	96	121	4,3
BTTMIDIN027311	350	55/0/55	126	136	117	96	121	4,3
BTTMIDIN027323	350	115/0/115	126	136	117	96	121	4,3
BTTMIDIN030311	400	55/0/55	126	136	127	96	121	5,2
BTTMIDIN030323	400	115/0/115	126	136	127	96	121	5,2
BTTMIDIN033311	500	55/0/55	126	136	127	96	121	5,3
BTTMIDIN033323	500	115/0/115	126	136	127	96	121	5,3

TRASFORMATORI MONOFASE DI SICUREZZA PER LAMPADE ALOGENE SINGLE-PHASE TRANSFORMERS FOR HALOGEN LAMPS

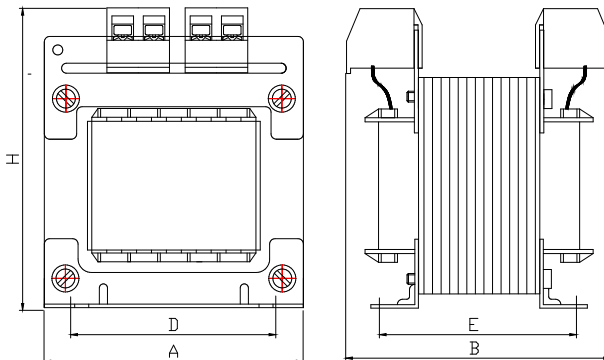

Trasformatore associato non resistente al cortocircuito
Trasformatore per apparecchi di illuminazione

*Associated transformer non-short-circuit proof
Transformer suitable for halogen lamps*

Norme di riferimento: EN 61558-2-6

Frequenza: 50/60 Hz

Tensione primaria: 0/230 V

Tensione secondaria: 12 V (disponibile anche 24 V)

Reference standards: EN 61558-2-6

Frequency: 50/60 Hz

Primary voltage: 0/230 V

Secondary voltage: 12 V (also available in 24 V version)

CODICE PART NUMBER	POTENZA POWER [VA]	Larghezza Width A [mm]	Profondità Depth B [mm]	Altezza Height H [mm]	Fissaggio Fixing D [mm]	Fissaggio Fixing E [mm]	Peso Weight [kg]
BTTMSLA004112	50	75	75	88	55	53	1,2
BTTMSLA007112	75	75	85	88	55	63	1,6
BTTMSLA010112	100	96	87	105	68	60	2,3
BTTMSLA013112	150	96	92	105	68	65	2,7
BTTMSLA016112	200	96	102	105	68	75	3,3
BTTMSLA019112	250	120	100	125	80	68	4,2
BTTMSLA022112	300	102	105	150	80	73	4,7
BTTMSLA025112	350	120	110	150	80	78	5,1
BTTMSLA028112	400	120	120	150	80	88	6,1
BTTMSLA031112	500	120	130	150	80	98	7,2
BTTMSLA034112	600	135	125	138	76	63	7,8
BTTMSLA040112	800	150	140	175	105	100	11,2
BTTMSLA046112	1000	150	160	150	105	120	13,8

TRASFORMATORI MONOFASE DI SICUREZZA IN CLASSE II SINGLE-PHASE CLASS II SAFETY TRANSFORMERS

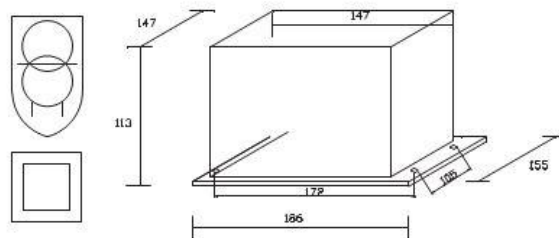

Trasformatore associato non resistente al cortocircuito
Trasformatore per alimentare apparecchi di illuminazione in ambienti umidi e polverosi
Trasformatore in doppio isolamento
Non adatti all'immersione anche se per breve tempo

*Associated transformer non-short-circuit proof
Transformer suitable for the supply of electrical power to lamps placed in humid/dusty places
Double insulation transformer
Transformers not suitable for immersion even for short times*

41

Norme di riferimento: EN 61558-2-6
Frequenza: 50/60 Hz
Classe di protezione ai contatti indiretti: II
Grado di protezione IP: 55
Tensione primaria: 230 V
Tensione secondaria: 12 V
Tensione secondaria: 24 V

*Reference standards: EN 61558-2-6
Frequency: 50/60 Hz
Protection class against accidental contacts: II
IP protection degree: 55
Primary voltage: 230 V
Secondary voltage: 12 V
Secondary voltage: 24 V*

CODICE PART NUMBER	POTENZA POWER [VA]	SECONDARIO SECONDARY [V]	Larghezza Width [mm]	Profondità Depth [mm]	Altezza Height [mm]
BTTMSCL2010412	100	12	101	85	85
BTTMSCL2010424	100	24	101	85	85
BTTMSCL2013412	150	12	101	85	85
BTTMSCL2013424	150	24	101	85	85
BTTMSCL2016412	200	12	101	85	85
BTTMSCL2016424	200	24	101	85	85
BTTMSCL2019412	250	12		vedere disegno - see drawing	
BTTMSCL2019424	250	24		vedere disegno - see drawing	
BTTMSCL2022412	300	12		vedere disegno - see drawing	
BTTMSCL2022424	300	24		vedere disegno - see drawing	
BTTMSCL2025412	350	12		vedere disegno - see drawing	
BTTMSCL2025424	350	24		vedere disegno - see drawing	
BTTMSCL2028412	400	12		vedere disegno - see drawing	
BTTMSCL2028424	400	24		vedere disegno - see drawing	
BTTMSCL2031412	500	12		vedere disegno - see drawing	
BTTMSCL2031424	500	24		vedere disegno - see drawing	
BTTMSCL2034412	600	12	vedere disegno - see drawing		163
BTTMSCL2034424	600	24	vedere disegno - see drawing		163
BTTMSCL2040412	800	12	vedere disegno - see drawing		163
BTTMSCL2040424	800	24	vedere disegno - see drawing		163

TRASFORMATORI MONOFASE PER CIRCUITO STAMPATO SINGLE-PHASE TRANSFORMERS FOR PRINTED CIRCUITS

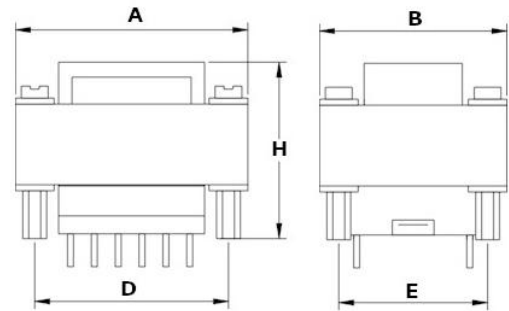
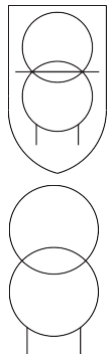
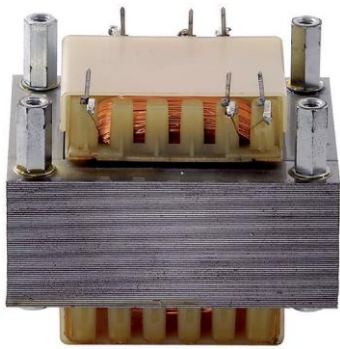

Trasformatore per l'alimentazione di circuiti elettronici

Transformer for electronic/printed board circuits

Norme di riferimento: EN 61558-2-4; EN 61558-2-6
Frequenza: 50/60 Hz

Reference standards: EN 61558-2-4; EN 61558-2-6
Frequency: 50/60 Hz

Tensione primaria: a richiesta
Tensione secondaria: a richiesta

Primary voltage: available
Secondary voltage: available

Possono essere forniti con protettore termico ripristinabile a primario

Available with restorable thermal protector on primary winding

CODICE PART NUMBER	POTENZA POWER [VA]	Larghezza Width A [mm]	Profondità Depth B [mm]	Altezza Height H [mm]	Fissaggio Fixing D [mm]	Fissaggio Fixing E [mm]	Piano foratura Drilling plan
BTTMA371	6	48,5	40,5	38	40	32	A
BTTMA372	8	48,5	40,5	43	40	32	A
BTTMA373	10	48,5	40,5	48	40	32	A
BTTMA374	12	48,5	40,5	48	40	32	A
BTTMA377	20	68,5	58,5	51	57	46	B
BTTMA378	25	68,5	58,5	51	57	46	B
BTTMA379	30	68,5	58,5	59	57	46	B
BTTMA380	32	68,5	58,5	59	57	46	B
BTTMA381	40	75,5	63	72	62,5	50	C
BTTMA382	50	75,5	63	77	62,5	50	C
BTTMA383	60	75,5	63	82	62,5	50	C

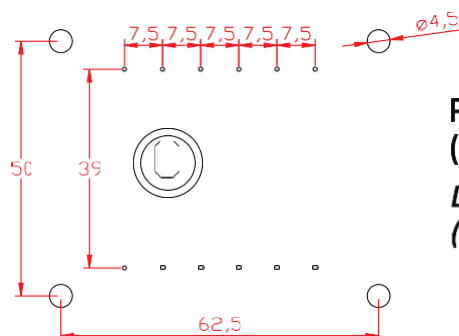
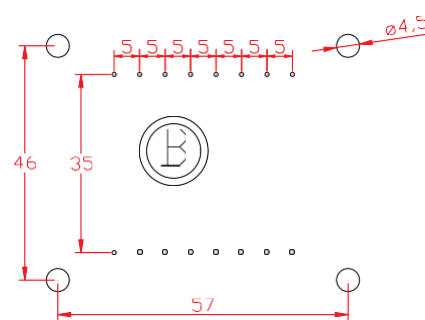
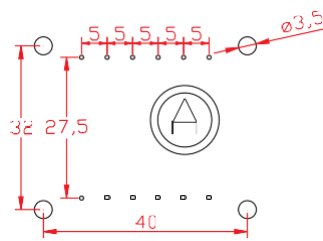

**PIANO DI FORATURA
(VISTO DA SOTTO)**
**DRILLING PLAN
(VIEW FROM BELOW)**

PIN $\varnothing 0,8$

TRASFORMATORI MONOFASE RESINATI PER CIRCUITO STAMPATO SINGLE-PHASE CAST-RESIN TRANSFORMERS FOR PRINTED CIRCUITS

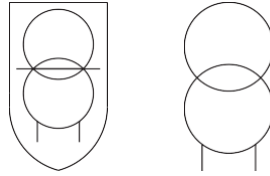

Trasformatore destinato all'alimentazione di circuiti elettronici

Transformer intended as power supply unit for electronic circuits

Norme di riferimento: EN 61558-2-4; EN 61558-2-6

Reference standards: EN 61558-2-4; EN 61558-2-6

Frequenza: 50/60 Hz

Frequency: 50/60 Hz

Tensione primaria: a richiesta

Primary voltage: available

Tensione secondaria: a richiesta

Secondary voltage: available

Disponibili anche con cavetti o morsettiere

Available with terminal blocks or connection cables

Disponibili anche con protettore termico ripristinabile nel primario

Available with thermal switch on primary

CODICE PART NUMBER	POTENZA POWER [VA]	Dimensione Dimension a [mm]	Dimensione Dimension b [mm]	Dimensione Dimension c [mm]	Dimensione Dimension d [mm]	Piano foratura Drilling plan	Tipo di scatolino Box type
BTTMA374.1	12	57	48	40	74	A	1
BTTMA377.1	20	70	59	56	87	B	2
BTTMA378.1	25	70	59	58,5	87	B	2
BTTMA380.1	32	70	59	64	87	B	2
BTTMA381.1	40	70	59	70	87	B	2
BTTMA382.1	50	80	67	70	101	C	2
BTTMA384.1	80	80	67	75	101	C	2

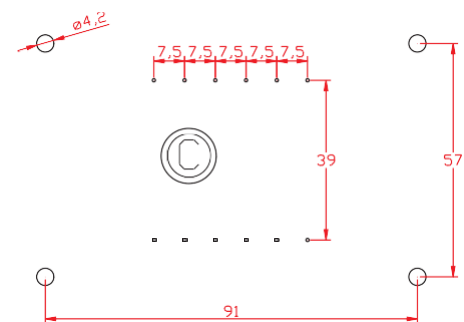
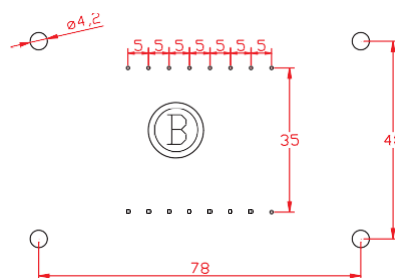
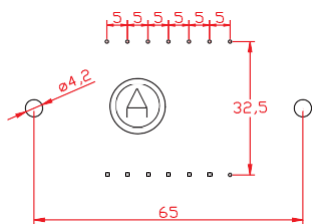
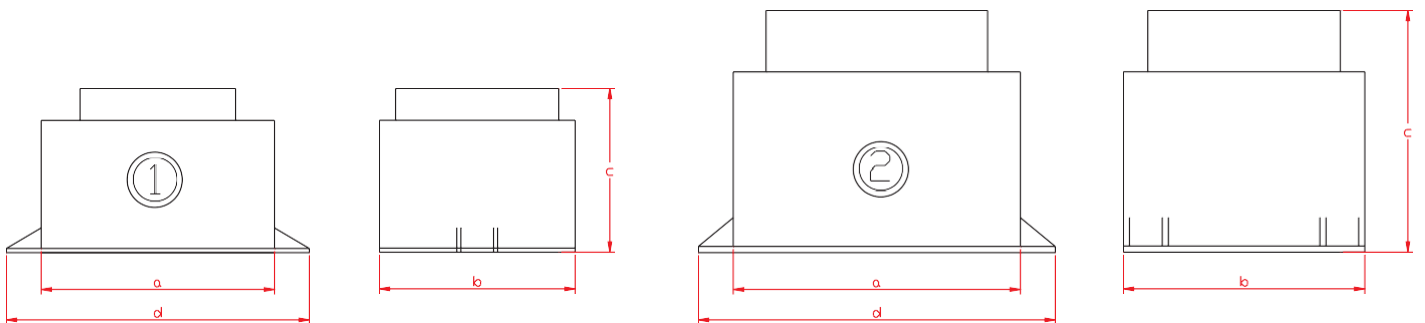

PIN $\phi 0.8$

PIANO DI FORATURA
(VISTO DA SOTTO)

DRILLING PLAN
(VIEW FROM BELOW)

TRASFORMATORI MONOFASE CON CONNESSIONE FAST-ON SINGLE-PHASE TRANSFORMERS WITH FAST-ON CONNECTION

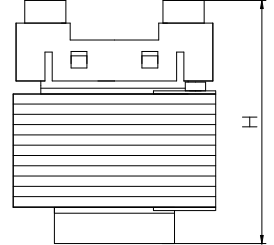
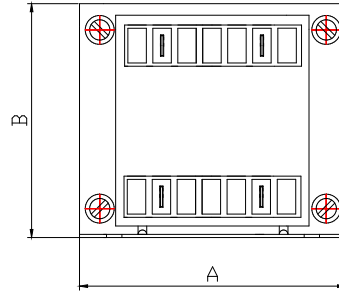
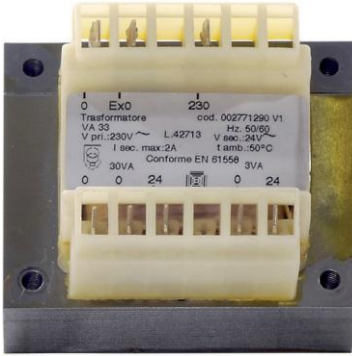

Trasformatore destinato ad alimentare circuiti elettronici

Transformer to be used in electronic/printed board circuits

Norme di riferimento: EN 61558-2-4; EN 61558-2-6

Reference standards: EN 61558-2-4; EN 61558-2-6

Frequenza: 50/60 Hz

Frequency: 50/60Hz

Tensione primaria: a richiesta

Primary voltage: available

Tensione secondaria: a richiesta

Secondary voltage: available

Fornibili con protettore termico ripristinabile al primario

Available with restorable thermal protector on primary

44

CODICE PART NUMBER	POTENZA Power [W]	Larghezza Width A [mm]	Profondità Depth B [mm]	Altezza Height H [mm]
BTTMA386	30	77,5	65	53
BTTMA387	40	77,5	65	58
BTTMA388	50	77,5	65	63
BTTMA389	60	77,5	65	67
BTTMA390	70	87	77	65
BTTMA391	90	87	77	74
BTTMA392	110	87	77	80
BTTMA393	130	87	77	85
BTTMA394	150	87	77	90
BTTMA395	200	87	77	100

TRASFORMATORI MONOFASE DI ISOLAMENTO SCHERMATI ISOLATING SCREENED SINGLE-PHASE TRANSFORMERS

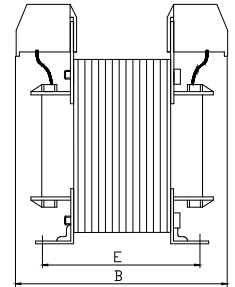
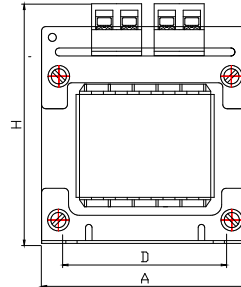
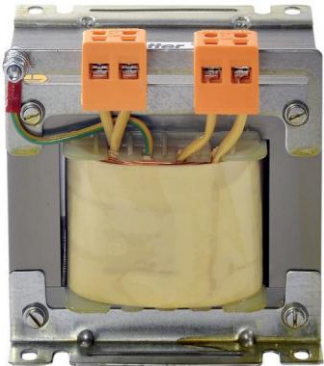

Trasformatore associato non resistente al cortocircuito
Trasformatore destinato ad alimentare impianti, sezioni di essi o apparecchiature ove sia necessaria la separazione dalla rete di alimentazione

Associated transformer non-short-circuit proof
Transformer suitable for electrical nets, parts of them or equipment which require separation from the power supply network

45

Norme di riferimento: EN 61558-2-4
Frequenza: 50/60 Hz
Tensione primaria: 0/230 V
Tensione secondaria: 0/230 V

Reference standards: EN 61558-2-4
Frequency: 50/60 Hz
Primary voltage: 0/230 V
Secondary voltage: 0/230 V

Dotato di schermo elettrostatico

Execution with screen

CODICE PART NUMBER	POTENZA POWER [VA]	Larghezza Width A [mm]	Profondità Depth B [mm]	Altezza Height H [mm]	Fissaggio Fixing D [mm]	Fissaggio Fixing E [mm]	Peso Weight [kg]
BTTMIS003	30	75	75	88	55	53	1,1
BTTMIS006	50	84	78	95	60	55	1,5
BTTMIS009	75	84	83	95	60	60	1,7
BTTMIS012	100	96	87	105	68	60	2,2
BTTMIS015	150	96	97	105	68	70	2,9
BTTMIS018	200	96	102	105	68	75	3,2
BTTMIS021	250	120	100	125	80	68	4,1
BTTMIS024	300	120	105	125	80	73	4,7
BTTMIS027	350	120	110	125	80	78	5,1
BTTMIS030	400	120	125	125	80	93	6,3
BTTMIS033	500	120	130	125	80	98	6,9
BTTMIS036	600	135	125	138	76	90	7,8
BTTMIS042	800	150	140	150	105	100	10,9
BTTMIS048	1000	150	160	150	105	120	14,0
BTTMIS057	1500	180	170	175	130	128	20,0
BTTMIS063	2000	192	184	185	145	139	25,1
BTTMIS069	2500	192	204	185	145	159	30,1
BTTMIS072	3000	192	234	210	145	189	37,0
BTTMIS078	4000	240	200	250	210	146	41,3
BTTMIS084	5000	240	220	250	210	166	47,9

TRASFORMATORI MONOFASE DI ISOLAMENTO PER USO MEDICALE SINGLE-PHASE ISOLATING TRANSFORMERS FOR MEDICAL LOCATIONS

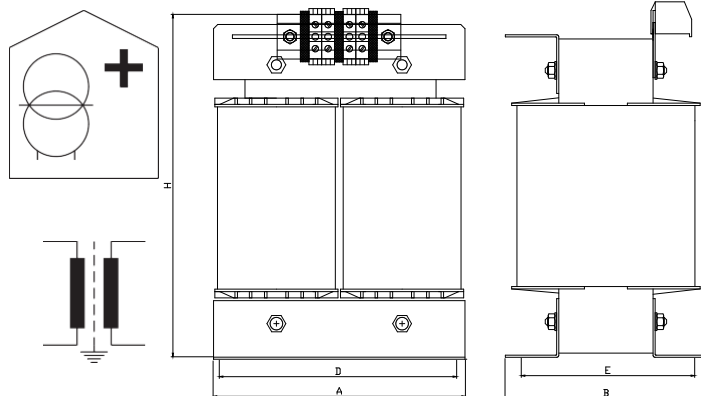

Trasformatore associato non resistente al cortocircuito
Trasformatore destinato all'installazione in impianti elettrici per l'alimentazione di locali ad uso medico

*Associated transformer non-short-circuit proof
Transformer specifically designed for the supply of medical locations*

Norme di riferimento: EN 61558-2-15
Frequenza: 50/60 Hz

*Reference standards: EN 61558-2-15
Frequency: 50/60 Hz*

Tensione primaria: 0/230 V

Primary voltage: 0/230 V

Tensione secondaria: 0/230 V (115/0/115 V)

Secondary voltage: 0/230 V (115/0/115 V)

Schermo elettrostatico

Electrostatic screen

Opzione: sonde per il rilevamento della temperatura

Available with temperature probes

CODICE PART NUMBER	POTENZA POWER [VA]	Larghezza Width A [mm]	Profondità Depth B [mm]	Altezza Height H [mm]	Fissaggio Fixing D [mm]	Fissaggio Fixing E [mm]	Peso Weight [kg]
BTTMIM033.1	500	150	130	175	105	90	9,5
BTTMIM048.1	1000	180	160	200	130	118	17,8
BTTMIM057.1	1500	192	174	210	145	123	23,2
BTTMIM063.1	2000	192	204	210	145	153	29,9
BTTMIM072.1	3000	200	190	300	150	124	35,1
BTTMIM084.1	5000	240	200	360	204	144	45,2
BTTMIM093.1	7500	240	220	360	204	154	56,4
BTTMIM099.1	10000	280	250	420	234	176	80,0

Per potenze superiori a 2 kVA,
esecuzione su due colonne

*For transformers over 2 kVA,
Coil-type core*

TRASFORMATORI MONOFASE DI ISOLAMENTO PER RETI FERROVIARIE SINGLE-PHASE ISOLATING TRANSFORMERS FOR RAILWAY SYSTEMS

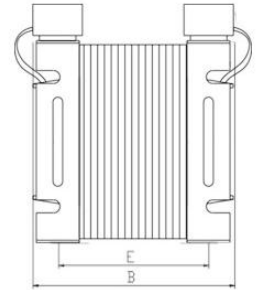
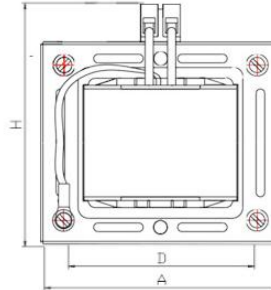
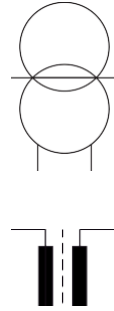
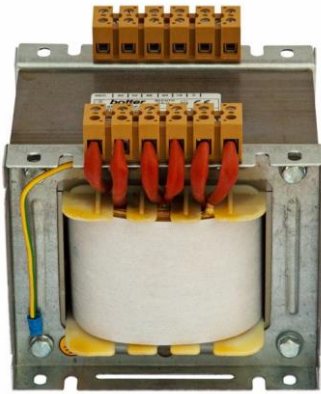

Trasformatore associato non resistente al cortocircuito
Trasformatore destinato ad essere incorporato in impianti di sicurezza e segnalamento di Trenitalia

Norme di riferimento: EN 61558-2-4
Regola: RFI IS-365:2008
Frequenza: 50/60 Hz
Tensione primaria: 0/210/220/230 V
Tensione secondaria: 0/145/150/155/165 V
Schermo elettrostatico
Lamierino magnetico a bassissima cifra di perdita

*Associated transformer non-short-circuit proof
Transformer to be incorporated into railways electrical
nets and signal systems*

*Reference standards: EN 61558-2-4
Rule RFI IS-365:2008
Frequency: 50/60 Hz
Primary voltage: 0/210/220/230 V
Secondary voltage: 0/145/150/155/165 V
Electrostatic screen
Low-iron-losses magnetic core*

CODICE PART NUMBER	POTENZA POWER [VA]	Larghezza Width A [mm]	Profondità Depth B [mm]	Altezza Height H [mm]	Fissaggio Fixing D [mm]	Fissaggio Fixing E [mm]	Peso Weight [kg]
BTTMIFS004.1	50	84	88	95	56	61	1,9
BTTMIFS010.1	100	96	102	105	57	76	3,2
BTTMIFS013.1	150	120	105	125	70	73	4,6
BTTMIFS016.1	200	120	115	125	70	83	5,6
BTTMIFS019.1	250	120	130	125	70	98	6,9
BTTMIFS022.1	300	120	140	125	70	108	7,7
BTTMIFS028.1	400	150	130	150	94	93	9,5
BTTMIFS031.1	500	150	150	150	94	113	12,3
BTTMIFS034.1	600	150	160	150	94	123	13,7
BTTMIFS040.1	800	180	160	175	116	118	18,0
BTTMIFS046.1	1000	180	180	175	116	138	22,0

CARATTERISTICHE GENERALI GENERAL FEATURES

- Trasformatore non protetto contro i contatti diretti ed indiretti, destinato ad essere incorporato in incogniti equipaggiamenti elettrici;
- Trasformatore non protetto contro il cortocircuito;
- Grado di protezione contro i contatti diretti IP00 secondo le norme EN 60529;
- Trasformatore destinato ad installazione fissa;
- Temperatura ambiente: -25 °C / +25 °C;
- Classe di sovratemperatura: B;
- Classe di isolamento: B;
- Costruzione secondo la norma EN 61558;
- Nucleo magnetico in lamierino toroidale a grani orientati a bassissima cifra di perdita;
- Avvolgimenti in filo di rame smaltato con resine in classe H (180 °C);
- Materiale e componenti usati per la realizzazione del trasformatore sono certificati e conformi alle relative norme;
- Per quantitativi elevati, a richiesta del cliente, è possibile ottenere certificazioni di conformità di Istituti Europei e Nordamericani;
- **TUTTI I TRASFORMATORI POSSONO ESSERE COSTRUITI CON SISTEMA DI ISOLAMENTO OMOLOGATO UL SECONDO LA NORMA UL 1446 "Systems of insulating materials".**
- *Transformers not protected against direct and indirect contacts, intended to be incorporated in unknown electric equipment;*
- *Transformers non-short-circuit proof and overloads;*
- *IP00 protection degree against direct contacts according to EN 60529 standard;*
- *Transformers intended for fix installation;*
- *Ambient temperature: -25 °C / +25 °C;*
- *Temperature class: B;*
- *Insulation class: B;*
- *EN 61558 manufacturing standards;*
- *Magnetic core in oriented grains sheets with very low power losses;*
- *H class (180 °C) magnetic copper wire windings;*
- *Materials and components used for transformers manufacturing are certified and conforming to their standards;*
- *For high quantity supplies, under customer specific request, it is possible to obtain conformity certifications issued by the major European and North American institutes;*
- ***ALL TRANSFORMERS MAY BE MANUFACTURED WITH UL HOMOLOGATED INSULATION SYSTEM ACCORDING TO UL 1446 STANDARD "Systems of insulating materials".***

NOTE AGGIUNTIVE PER L'UTILIZZO E L'INSTALLAZIONE ADDITIONALS REMARKS FOR USE AND INSTALLATION

- Per collegare il trasformatore toroidale utilizzare appositi morsetti collegandoli ai conduttori di entrata e uscita senza accorciare quelli esistenti;
- Evitare di accostare il trasformatore toroidale alla lampada alogena alimentata ed installarlo ad una distanza minima di 200 mm;
- Per il collegamento preferire i sistemi in parallelo e ad anello (*loop*);
- I trasformatori toroidali possono essere "dimmerati" attraverso apposito regolatore adatto per carichi induttivi;
- Il fusibile di protezione del primario è sufficiente anche alla protezione del secondario se il trasformatore è usato per l'alimentazione di lampade alogene con linee brevi sul secondario, in caso di utilizzi differenti proteggerlo con fusibili seguendo le indicazioni della tabella nella pagina seguente.
- *To connect the transformers to specific terminals use input and output leads, without shortening the existing ones;*
- *Do not place the transformer beside an halogen lamp; put it at least 200 mm away from the lamp;*
- *Parallel and loop connection systems are preferable;*
- *Toroidal transformers can be "dimmed" by a specific regulator suitable for inductive loads;*
- *Primary protection fuse guarantees also protection to the secondary circuit if the transformer is used to supply halogen lamps with short lines on the secondary. In case of different uses, protect the secondary exit with fuses according to the tab reported in the following page.*

SCELTA DEI FUSIBILI DI PROTEZIONE E DISSIPAZIONE MASSIMA AID TABLE FOR FUSES CHOICE AND POWER DISSIPATION

POTENZA POWER [VA]	PRIMARIO PRIMARY		SECONDARIO SECONDARY		DISSIPAZIONE DISSIPATION [W]
	220/230 V	12 V	24 V	48 V	
20	0,16	2,5	1,25	0,63	4
50	0,25	5	2	1	7
60	0,315	6,3	2,15	1,25	8
100	0,5	10	5	2,5	10
150	0,8	12	6,3	3,15	18
200	1	16	10	5	20
250	1,25	20	12	6,3	22
300	1,6	25	16	6,3	25
400	2	35	16	10	38
500	2,5	40	20	12	45

- Tutti i fusibili si intendono di tipo ritardato;
- Con sfondo evidenziato fusibili tipo 5x20 in vetro non disponibili o con portate non normalizzate; si consiglia di scegliere fusibili di tipo aM;
- Per la protezione possono essere utilizzati, in alternativa ai fusibili, anche interruttori automatici;
- I dispositivi di protezione devono essere conformi alle relative norme;
- La dissipazione si intende indicativa per il calcolo della temperatura all'interno di quadri elettrici;
- Per caratteristiche non comprese nella tabella applicare, per interpolazione, lo stesso principio di calcolo.

- All the fuses are of delayed type;
- Blue background cells indicate 5x20 glass fuses which may be not available or of non-normalized values; we recommend the use of aM type fuses;
- Automatic switches in place of fuses, are also useful for transformer protection;
- Protection devices must be conforming to their own standards;
- Dissipation values are indicative and useful only for temperature calculation inside electrical cabinet;
- For powers not included in the above tab, it is possible to calculate them by interpolation.

**TRASFORMATORI TOROIDALI
TOROIDAL TRANSFORMERS**

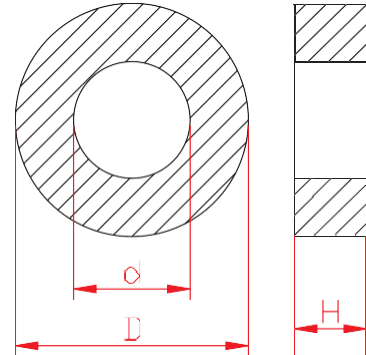

**ESEMPI TIPICI DI INSTALLAZIONE
TYPICAL INSTALLATION EXAMPLES**

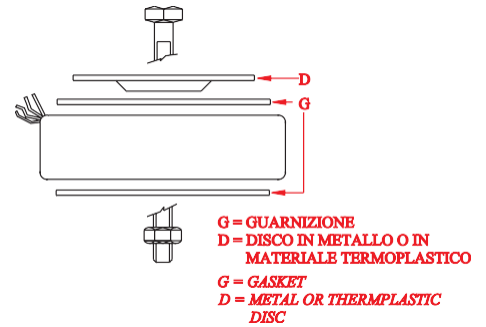
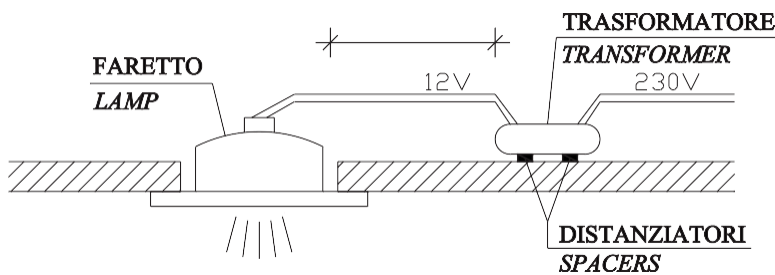

**AD ANELLO (CONSIGLIATA)
LOOP (RECOMMENDED)**

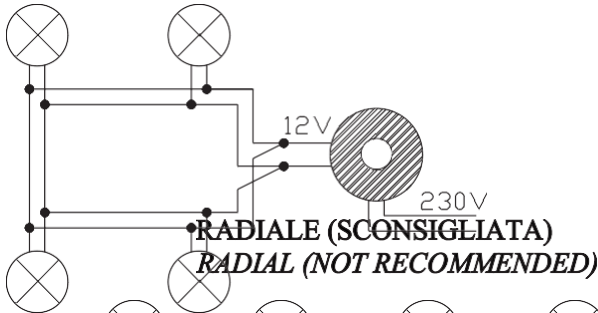

**PARALLELA (CONSIGLIATA)
PARALLEL (RECOMMENDED)**

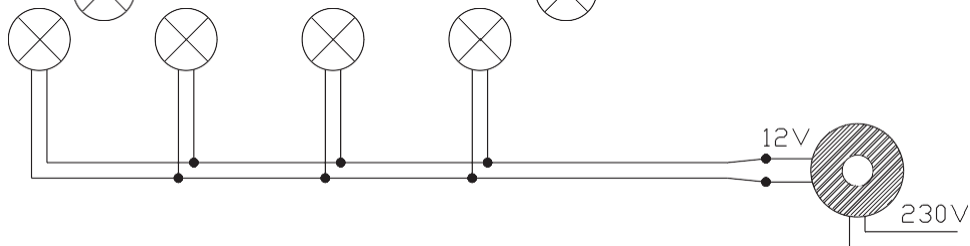
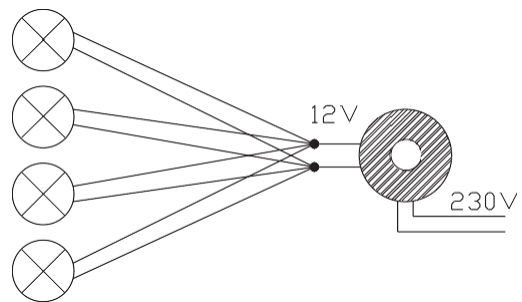

TRASFORMATORI TOROIDALI TOROIDAL TRANSFORMERS



Trasformatore associato non resistente al cortocircuito
Trasformatore destinato all'alimentazione di apparecchi di illuminazione e apparecchiature elettroniche

*Associated transformer non-short-circuit proof
Transformer designed for lighting devices and electronic equipment power supply*

Norme di riferimento: EN 61558-2-6

Frequenza: 50/60 Hz

Tensione primaria: 0/230 V

Tensione secondaria: 0/12 V (disponibili anche a 24 V)

Possono essere forniti con protettore termico ripristinabile al primario (BTTTRxxxP)

Reference standards: EN 61558-2-6

Frequency: 50/60 Hz

Primary voltage: 0/230 V

Secondary voltage: 0/12 V (24 V available)

Available with restorable thermal protector on primary winding (BTTTRxxxP)

CODICE PART NUMBER	POTENZA POWER [VA]	Diametro esterno External diameter D [mm]	Diametro interno Internal diameter d [mm]	Spessore Thickness H [mm]	Peso Weight [kg]	ESECUZIONE EXECUTION
BTTTR246	20	75	32	30	0,45	
BTTTR246P	20	75	32	30	0,50	Protetta / Protected
BTTTR250	50	79	24	33	0,66	
BTTTR250P	50	79	24	33	0,71	Protetta / Protected
BTTTR253	60	88	34	36	0,78	
BTTTR253P	60	88	34	36	0,83	Protetta / Protected
BTTTR257	100	98	30	38	1,08	
BTTTR257P	100	98	30	38	1,13	Protetta / Protected
BTTTR263	150	103	41	46	1,44	
BTTTR263P	150	103	41	46	1,49	Protetta / Protected
BTTTR264	200	112	43	45	1,95	
BTTTR264P	200	112	43	45	2,00	Protetta / Protected
BTTTR265	250	113	35	55	2,34	
BTTTR265P	250	113	35	55	2,39	Protetta / Protected
BTTTR266	300	132	42	46	2,85	
BTTTR266P	300	132	42	46	2,90	Protetta / Protected
BTTTR267	400	135	47	55	3,46	
BTTTR267P	400	135	47	55	3,51	Protetta / Protected
BTTTR268	500	145	54	55	4,27	
BTTTR268P	500	145	54	55	4,32	Protetta / Protected

CARATTERISTICHE GENERALI GENERAL FEATURES

- Trasformatore non protetto contro i contatti diretti ed indiretti, destinato ad essere incorporato in incogniti equipaggiamenti elettrici;
 - Trasformatore non protetto contro il cortocircuito;
 - Grado di protezione contro i contatti diretti IP00 secondo le norme EN 60529;
 - Trasformatore destinato ad una installazione fissa;
 - Temperatura ambiente: -25 °C / +40 °C
 - Classe di sovratemperatura: B/F/H;
 - Classe di isolamento: B/F/H;
 - Costruzione secondo la norma EN 61558;
 - Nucleo magnetico in lamierino al silicio a bassa cifra di perdita;
 - Trasformatore tropicalizzato con vernici essiccanti in aria o a forno in classe H;
 - Avvolgimenti in filo di rame o alluminio smaltato con resine in classe H (180°C);
 - Varie posizioni di montaggio permesse dalla particolare conformazione del supporto metallico;
 - Materiale e componenti usati per la realizzazione del trasformatore sono certificati e conformi alle relative norme;
 - Per quantitativi elevati, a richiesta del cliente, è possibile ottenere certificazioni di conformità di Istituti Europei e Nordamericani;
 - **TUTTI I TRASFORMATORI POSSONO ESSERE COSTRUITI CON SISTEMA DI ISOLAMENTO OMOLOGATO UL SECONDO LA NORMA UL 1446 "Systems of insulating materials."**
- *Transformers not protected against direct and indirect contacts, intended to be incorporated in unknown electric equipment;*
 - *Transformers non-short-circuit proof;*
 - *IP00 protection degree against direct contacts according to EN 60529 standard;*
 - *Transformers intended for fix installation;*
 - *Ambient temperature: -25 °C / +40 °C*
 - *Temperature class: B/F/H;*
 - *Insulation class: B/F/H;*
 - *EN 61558 manufacturing standards;*
 - *Lamination core manufactured using silicon steel sheets characterized by low power losses;*
 - *Transformers tropicalized by using H class varnish, drying process by natural air or by oven;*
 - *H class (180°C) magnetic copper or aluminium wire windings;*
 - *Intended for different assembling layouts due to a big number of available metallic supports;*
 - *Materials and components used for transformer manufacturing are certified and conforming to their standards;*
 - *For high quantity supplies, under customer specific request, it is possible to obtain conformity certifications issued by the major European and North American institutes;*
 - ***ALL TRANSFORMERS MAY BE MANUFACTURED WITH UL HOMOLOGATED INSULATION SYSTEM ACCORDING TO UL 1446 STANDARD "Systems of insulating materials".***

SCELTA DEI FUSIBILI DI PROTEZIONE E DISSIPAZIONE MASSIMA AID TABLE FOR FUSES CHOICE AND POWER DISSIPATION

POTENZA POWER [kVA]	PRIMARIO O SECONDARIO (tensione di utilizzo) PRIMARY OR SECONDARY (operative voltage)						DISSIPAZIONE DISSIPATION [W]
	110 V	230V	380 V	400 V	440 V	500 V	
0,5	4	2	2	2	2	2	60
1	6	4	2	2	2	2	115
2	16	6	4	4	4	4	225
3	16	8	6	6	6	4	340
4	25	16	8	6	6	6	450
5	32	16	8	8	8	6	560
7	40	20	16	16	10	10	800
8	50	25	16	16	16	10	900
10	63	32	16	16	16	16	1125
15	80	40	25	25	20	20	1700
20	125	63	32	32	32	25	2250
25	160	80	40	40	40	32	2800
30	160	80	50	50	40	40	3350
40	250	125	63	63	63	50	4500

- Si consiglia di utilizzare fusibili di tipo aM per la protezione dei primari e di tipo gG per la protezione dei secondari (compatibilmente con il carico alimentato);
 - Per la protezione possono essere utilizzati, in alternativa ai fusibili, anche interruttori automatici;
 - I dispositivi di protezione devono essere conformi alle relative norme;
 - La dissipazione si intende indicativa per il calcolo della temperatura all'interno di quadri elettrici;
 - Per caratteristiche non comprese nella tabella applicare, per interpolazione, lo stesso principio di calcolo.
- *We suggest to use aM type fuses for the primary protection and gG type for the secondary protection (compatible with the type of load supplied);*
 - *Automatic switches in place of fuses, are also helpful for transformer protection;*
 - *Protection devices must be conforming to their own standards;*
 - *Dissipation values are indicative and useful only for temperature calculation inside electrical cabinet;*
 - *For rated powers not included in the tab, it is possible to obtain results by interpolation.*

COLLEGAMENTI DEI TRASFORMATORI TRIFASE THREE-PHASE TRANSFORMER CONNECTIONS

I trasformatori trifase possono avere diverse tipologie di collegamenti dei propri avvolgimenti; la scelta viene fatta in base alle necessità dell'utilizzatore.

In funzione dei vari collegamenti i trasformatori vengono suddivisi nei cosiddetti "gruppi vettoriali", che sono caratterizzati dagli spostamenti angolari fra primario e secondario.

Le sigle di designazione dei gruppi sono le seguenti:

- una lettera maiuscola che definisce la tensione del primario (D per triangolo, Y per stella e Z per zig-zag)
- una lettera minuscola che definisce la tensione del secondario (d per triangolo, y per stella e z per zig-zag)
- un numero che denota lo spostamento angolare tra primario e secondario, il quale deriva dividendo per 30 l'angolo di spostamento
- se l'avvolgimento è collegato a stella o a zig-zag è presente il terminale di neutro, definito con la sigla N o n. Gli schemi più comuni e raccomandati sono quelli appartenenti ai gruppi 0 o 11 ed in particolare quelli con sigla Dyn11

Different primary and secondary windings connections are possible in three-phase transformers; choice depends on user needs.

Depending on primary and secondary windings connections, three-phase transformers are divided into "vector groups" which are characterized by different phase displacements between primary and secondary voltages.

Groups designation codes are the following:

- *a capital letter defines the primary voltage (D for delta, Y for star and Z for zig-zag)*
- *a small letter defines the secondary voltage (d for delta, y for star and z for zig-zag)*
- *a number defines the angular displacement between primary to secondary voltage, which is obtained dividing by 30 the real displacement angle.*
- *If the windings are star or zig-zag connected, the neutral conductor terminal, defined by N or n letter, is also available. Most common and recommended connections are those belonging to 0 or 11 groups and, in particular, the Dyn11*

CARATTERISTICHE	SIGLA INITIALS	FEATURES
Non permette il passaggio della terza armonica Gli squilibri di corrente provocano forti squilibri di tensione se il neutro primario non è collegato È disponibile la connessione del neutro sia al primario che al secondario	Yy0 Yy6	Does not allow the passage of the third harmonic Current unbalances produce strong voltage unbalances if the primary neutral is not connected Neutral conductor terminals are available both on primary and on secondary windings
Permette il passaggio della terza armonica Gli squilibri hanno poche ripercussioni sull'impianto Non è disponibile la connessione del neutro	Dd0 Dd6	Allows the passage of the third harmonic The unbalances have few repercussions on the net Neutral conductor terminals are not available
Permette il passaggio della terza armonica È disponibile la connessione del neutro sul secondario	Dy11 Dy5	Allows the passage of the third harmonic Neutral conductor terminals is available only at secondary winding side
Permette il passaggio della terza armonica Non è disponibile la connessione del neutro sul secondario	Yd11 Yz5	Allows the passage of the third harmonic Neutral conductor terminals is available only at primary windings side
Non permette il passaggio della terza armonica Gli squilibri hanno poche ripercussioni sull'impianto È disponibile la connessione del neutro sia al primario che al secondario Maggior numero di spire dovuto allo zig-zag	Yz11 Yz5	Does not allow the passage of the third harmonic The unbalances have few repercussions on the net Neutral conductor terminals are available both on primary and on secondary windings Great number of turns due to the zig-zag
Permette il passaggio della terza armonica Non è disponibile la connessione del neutro sul primario Gli squilibri hanno poche ripercussioni sull'impianto Maggior numero di spire dovuto allo zig-zag	Dz0 Dz6	Allows the passage of the third harmonic The unbalances have few repercussions on the net Neutral conductor terminals is available only at secondary windings side Big number of turns due to the zig-zag

TRASFORMATORI TRIFASE DI SICUREZZA THREE-PHASE SAFETY TRANSFORMERS

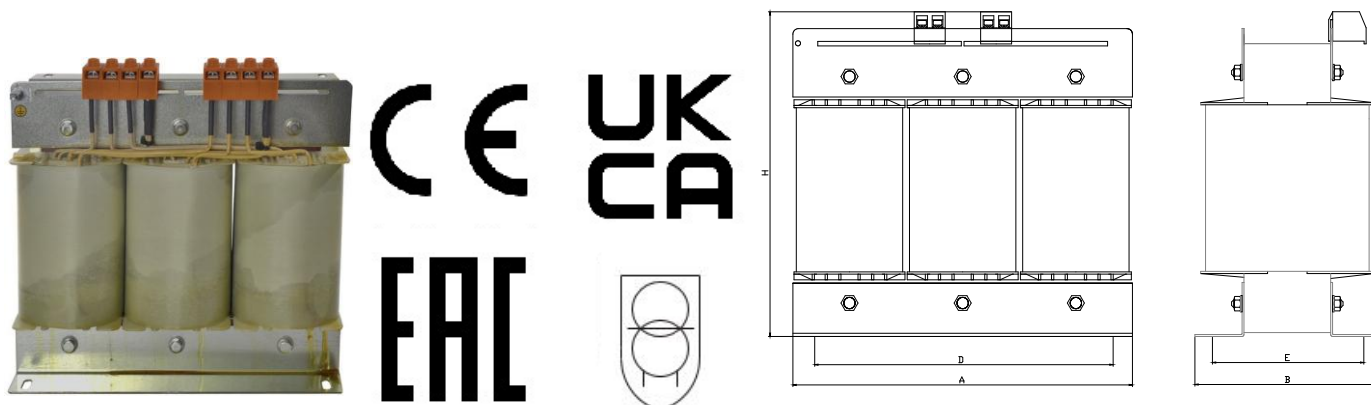

Trasformatore associato non resistente al cortocircuito
Trasformatore da incorporare in apparati elettrici specifici

*Associated transformer non-short-circuit-proof
Transformer for special electric equipment*

Norme di riferimento: EN 61558-2-6
Frequenza: 50/60 Hz
Tensione primaria: inferiore a 1100 V
Tensione secondaria: inferiore a 50 V
Gruppo vettoriale: a richiesta

*Reference standards: EN 61558-2-6
Frequency: 50/60 Hz
Primary voltage: lower than 1100 V
Secondary voltage: lower than 50 V
Vector group: available*

CODICE PART NUMBER	POTENZA POWER [kVA]	Larghezza Width A [mm]	Profondità Depth B [mm]	Altezza Height H [mm]	Fissaggio Fixing D [mm]	Fissaggio Fixing E [mm]	Peso Weight [kg]
BTTTS182	0,5	180	105	200	150	71	7,1
BTTTS183	1	180	125	200	150	91	11,0
BTTTS184	1,5	240	120	250	200	77	16,0
BTTTS185	2	240	130	250	200	87	19,2
BTTTS186	2,5	240	140	250	200	97	22,5
BTTTS187	3	240	155	250	200	112	26,7
BTTTS188	3,5	300	140	300	250	102	31,4
BTTTS189	4	300	140	300	250	102	32,8
BTTTS190	5	300	160	300	250	122	40,9
BTTTS191	6	300	170	300	250	132	47,1
BTTTS192	7	300	180	300	250	142	52,0
BTTTS193	8	360	170	350	325	135	62,6
BTTTS194	10	360	190	350	325	155	75,5
BTTTS195	12	420	180	400	375	140	85,7
BTTTS196	15	420	190	400	375	150	95,8
BTTTS197	16	420	220	400	375	160	105,9

TRASFORMATORI TRIFASE DI ISOLAMENTO THREE-PHASE ISOLATING TRANSFORMERS

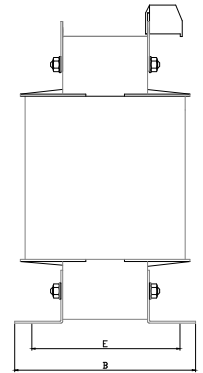
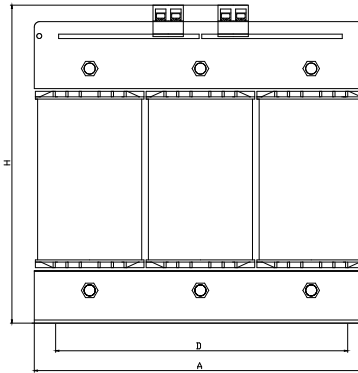

Trasformatore associato non resistente al cortocircuito
Trasformatore da incorporare in apparati elettrici specifici

*Associated transformer non-short-circuit proof
Transformer for special electric equipment*

Norme di riferimento: EN 61558-2-4
Frequenza: 50/60 Hz
Tensione primaria: inferiore a 1100 V
Tensione secondaria: da 50 V a 1000 V
Gruppo vettoriale: a richiesta

*Reference standards: EN 61558-2-4
Frequency: 50/60 Hz
Primary voltage: lower than 1100 V
Secondary voltage: from 50 V to 1000 V
Vector group: available*

CODICE PART NUMBER	POTENZA POWER [kVA]	Larghezza Width A [mm]	Profondità Depth B [mm]	Altezza Height H [mm]	Fissaggio Fixing D [mm]	Fissaggio Fixing E [mm]	Peso Weight [kg]
BTTT182	0,5	180	140	160	150	77	6,5
BTTT183	1	180	160	160	150	97	11,0
BTTT184	1,5	240	145	210	200	88	16,0
BTTT185	2	240	150	210	200	98	18,0
BTTT186	2,5	240	160	210	200	108	19,5
BTTT187	3	240	170	210	200	123	21,0
BTTT188	3,5	300	180	255	250	105	29,0
BTTT189	4	300	190	255	250	115	30,5
BTTT190	5	300	200	255	250	125	36,0
BTTT191	6	300	220	255	250	135	40,5
BTTT192	7	300	230	255	250	145	46,0
BTTT193	8	360	280	310	325	145	48,0
BTTT194	10	360	300	310	325	155	55,0
BTTT195	12	420	370	360	375	155	97,0
BTTT196	15	420	380	360	375	165	140,0
BTTT197	20	420	400	360	375	175	155,0
BTTT198	25	480	420	410	425	210	170,0
BTTT199	30	480	430	410	425	220	190,0
BTTT200	40	480	450	410	425	240	210,0
BTTT201	50	480	400	450	225	210	240,0
BTTT202	60	540	400	550	225	210	270,0
BTTT203	70	540	460	560	225	210	330,0
BTTT204	80	540	460	560	480	210	350,0
BTTT205	100	600	480	580	560	220	400,0

TRASFORMATORI TRIFASE DI ISOLAMENTO IN BOX THREE-PHASE CASED ISOLATING TRANSFORMERS

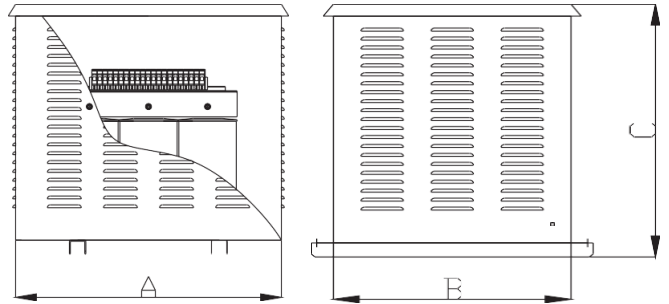

Trasformatore associato non resistente al cortocircuito
Trasformatore assemblato in cassetta con grado di protezione IP23 / IP44 / IP54 tale da garantire lo smaltimento del calore generato mediante aria a circolazione naturale (AN) Su richiesta sono disponibili cassette con grado di protezione IP diverso, associate a dispositivi di protezione per il trasformatore e per il raffreddamento mediante ventilazione forzata.

*Associated transformer non-short-circuit proof
Transformer assembled to IP23 / IP44 / IP54 boxes specifically manufactured for heat disposing by natural air circulation (AN)
Boxes with different IP protection degree are also available, in association with electrical protections and forced air cooling systems.*

57

Norme di riferimento: EN 61558-2-4
Frequenza: 50/60 Hz
Tensione primaria: inferiore a 1100 V
Tensione secondaria: da 50 V a 1000 V
Gruppo vettoriale: a richiesta

*Reference standards: EN 61558-2-4
Frequency: 50/60 Hz
Primary voltage: lower than 1100 V
Secondary voltage: from 50 V to 1000 V
Vector group: available*

CODICE PART NUMBER	POTENZA POWER [kVA]	Larghezza Width A [mm]	Profondità Depth B [mm]	Altezza Height H [mm]	Peso Weight [kg]
BTTT182B	0,5	350	350	400	22
BTTT183B	1	350	350	400	26
BTTT184B	1,5	450	330	450	31
BTTT185B	2	450	330	450	37
BTTT186B	2,5	450	330	450	41
BTTT187B	3	450	330	450	46
BTTT188B	3,5	610	360	430	61
BTTT189B	4	610	360	430	66
BTTT190B	5	610	360	430	72
BTTT191B	6	610	360	430	80
BTTT192B	7	610	360	430	86
BTTT193B	8	610	360	430	94
BTTT194B	10	610	360	430	106
BTTT195B	12	700	460	600	128
BTTT196B	15	700	460	600	141
BTTT197B	20	700	460	600	167
BTTT198B	25	700	460	600	186
BTTT199B	30	700	460	600	212
BTTT200B	40	900	650	800	255
BTTT201B	50	900	650	800	281
BTTT202B	60	900	650	800	310
BTTT203B	70	900	650	800	345
BTTT204B	80	900	650	800	400
BTTT205B	100	900	650	800	460

TRASFORMATORI TRIFASE “UL RECOGNIZED” “UL RECOGNIZED” THREE-PHASE TRANSFORMERS

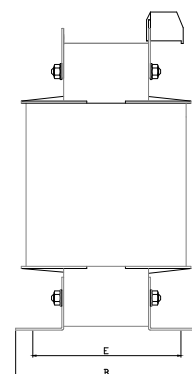
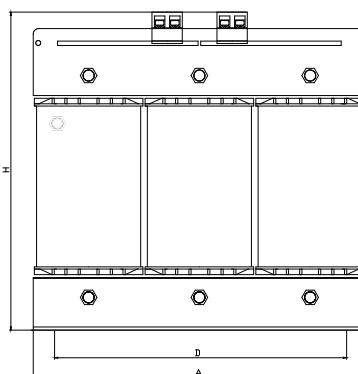
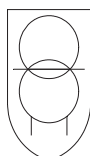
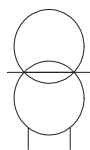

Trasformatore associato non resistente al cortocircuito
Trasformatore da incorporare in apparati elettrici specifici

Norme di riferimento: UL5085 e CSA C22.2 No 66
Frequenza: 50/60 Hz
Classe termica: F
Classe di isolamento: F
Temperatura ambiente 40 °C

Trasformatore di tipo “Industrial control” adatto anche ad essere installato in quadri elettrici costruiti in accordo alla norma UL 508A “Standard for industrial control panels”.

Gruppo vettoriale: a richiesta

Le lettere XX presenti nella codifica del trasformatore sono sostituite in fase d'ordine da un numero di due o tre cifre e seguite dalla dicitura UL o PF.UL. I numeri assegnati identificano univocamente il trasformatore ordinato.
Trasformatore personalizzabile con diverse tensioni e prese di regolazione sia al primario che al secondario.

*Associated transformer non-short-circuit proof
Transformer for special electric equipment*

*Reference standards: UL5085 and CSA C22.2 No 66
Frequency: 50/60 Hz
Thermal class: F
Insulation class: F
Ambient temperature: 40 °C*

Industrial control transformer suitable for installation in electric equipment manufactured according to UL508A “Standard for industrial control panels”.

Vector group: available

*XX letters in transformers part number are changed with two or three digit numbers, followed by UL or PF.UL. Those numbers will identify product.
Transformer suitable to be customized with different rated voltages and regulation taps both at primary and secondary end.*

TRASFORMATORI TRIFASE "UL RECOGNIZED" "UL RECOGNIZED" THREE-PHASE TRANSFORMERS

CODICE PART NUMBER	POTENZA POWER [kVA]	Larghezza Width A [mm]	Profondità Depth B [mm]	Altezza Height H [mm]	Fissaggio Fixing D [mm]	Fissaggio Fixing E [mm]	Peso Weight [kg]
TTF2.00500.XX.UL	0,5	180	115	200	150	81	9,1
TTF2.00630.XX.UL	0,63	180	120	200	150	86	9,6
TTF2.00800.XX.UL	0,8	180	120	200	150	86	10,2
TTF2.01000.XX.UL	1	180	130	200	150	96	12,0
TTF2.01300.XX.UL	1,3	240	130	250	200	87	17,8
TTF2.01600.XX.UL	1,6	240	130	250	200	87	18,9
TTF2.02000.XX.UL	2	240	140	250	200	97	23,1
TTF2.02200.XX.UL	2,2	240	140	250	200	97	23,6
TTF2.02500.XX.UL	2,5	300	150	300	250	112	28,8
TTF2.02800.XX.UL	2,8	300	150	300	250	112	30,4
TTF2.03000.XX.UL	3	300	160	300	250	122	35,6
TTF2.03200.XX.UL	3,2	300	160	300	250	122	36,1
TTF2.03500.XX.UL	3,5	300	160	300	250	122	37,1
TTF2.04000.XX.UL	4	300	160	300	250	122	38,1
TTF2.04500.XX.UL	4,5	300	170	300	250	132	43,3
TTF2.05000.XX.UL	5	300	180	300	250	142	52,4
TTF2.05500.XX.UL	5,5	360	170	350	325	135	48,6
TTF2.06000.XX.UL	6	360	180	350	325	145	66,4
TTF2.06300.XX.UL	6,3	360	180	350	325	145	67,9
TTF2.07000.XX.UL	7	360	190	350	325	155	73,2
TTF2.08000.XX.UL	8	420	180	400	375	140	84,2
TTF2.09000.XX.UL	9	420	190	400	375	150	87,8
TTF2.10000.XX.UL	10	420	200	400	375	160	101,7
TTF2.11000.XX.UL	11	420	210	400	375	170	106,1
TTF2.12000.XX.UL	12	420	220	400	375	180	116,3
TTF2.13000.XX.UL	13	420	230	400	375	190	125,4
TTF2.14000.XX.UL	14	420	230	400	375	190	131,2
TTF2.15000.XX.UL	15	420	240	400	375	200	139,8
TTF2.16000.XX.UL	16	480	220	450	425	184	145,5
TTF2.17000.XX.UL	17	480	230	450	425	194	158,3
TTF2.18000.XX.UL	18	480	240	450	425	204	172,5

TRASFORMATORI TRIFASE "UL RECOGNIZED" "UL RECOGNIZED" THREE-PHASE TRANSFORMERS

CODICE PART NUMBER	POTENZA POWER [kVA]	Larghezza Width A [mm]	Profondità Depth B [mm]	Altezza Height H [mm]	Fissaggio Fixing D [mm]	Fissaggio Fixing E [mm]	Peso Weight [kg]
TTF3.01000.XX.UL	1	180	130	200	150	96	12,0
TTF3.01300.XX.UL	1,3	240	130	250	200	97	17,8
TTF3.01600.XX.UL	1,6	240	130	250	200	97	18,9
TTF3.02000.XX.UL	2	240	140	250	200	112	23,1
TTF3.02200.XX.UL	2,2	300	150	300	250	112	28,8
TTF3.02500.XX.UL	2,5	300	150	300	250	122	28,8
TTF3.02800.XX.UL	2,8	300	150	300	250	132	30,4
TTF3.03000.XX.UL	3	300	160	300	250	142	35,6
TTF3.03200.XX.UL	3,2	300	160	300	250	142	36,1
TTF3.03500.XX.UL	3,5	300	160	300	250	142	37,1
TTF3.04000.XX.UL	4	300	160	300	250	152	38,1
TTF3.04500.XX.UL	4,5	300	170	300	250	162	43,3
TTF3.05000.XX.UL	5	360	170	350	325	135	48,6
TTF3.05500.XX.UL	5,5	360	170	350	325	145	48,6
TTF3.06000.XX.UL	6	360	180	350	325	155	66,4
TTF3.06300.XX.UL	6,3	420	180	400	375	140	84,2
TTF3.07000.XX.UL	7	420	190	400	375	150	87,8
TTF3.08000.XX.UL	8	420	180	400	375	160	84,2
TTF3.09000.XX.UL	9	420	190	400	375	170	87,8
TTF3.10000.XX.UL	10	420	200	400	375	180	101,7
TTF3.11000.XX.UL	11	420	210	400	375	190	106,1
TTF3.12000.XX.UL	12	420	220	400	375	200	116,3
TTF3.13000.XX.UL	13	480	220	450	425	164	145,5
TTF3.14000.XX.UL	14	480	220	450	425	164	145,5
TTF3.15000.XX.UL	15	480	230	450	425	174	145,5
TTF3.16000.XX.UL	16	480	240	450	425	184	145,5
TTF3.17000.XX.UL	17	480	250	450	425	194	158,3
TTF3.18000.XX.UL	18	480	260	450	425	204	172,5

TRASFORMATORI TRIFASE “UL RECOGNIZED” “UL RECOGNIZED” THREE-PHASE TRANSFORMERS

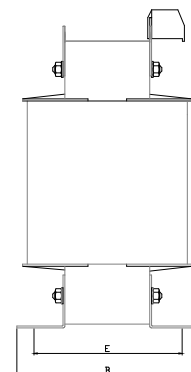
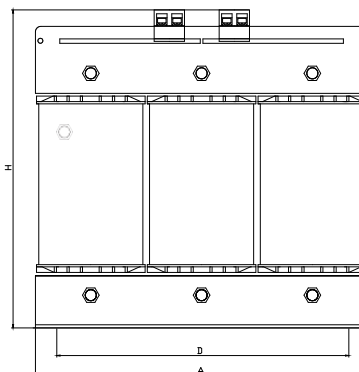

Trasformatore associato non resistente al cortocircuito
Trasformatore da incorporare in apparati elettrici specifici

Norme di riferimento: UL5085 e CSA C22.2 No 66
Frequenza: 50/60 Hz
Classe termica: H
Classe di isolamento: H
Temperatura ambiente 40 °C

Trasformatore di tipo “Industrial control” adatto anche ad essere installato in quadri elettrici costruiti in accordo alla norma UL 508A “Standard for industrial control panels”.

Gruppo vettoriale: a richiesta

Le lettere XX presenti nella codifica del trasformatore sono sostituite in fase d’ordine da un numero di due o tre cifre e seguite dalla dicitura UL o PF.UL. I numeri assegnati identificano univocamente il trasformatore ordinato.
Trasformatore personalizzabile con diverse tensioni e prese di regolazione sia al primario che al secondario.

*Associated transformer non-short-circuit proof
Transformer for special electric equipment*

*Reference standards: UL5085 and CSA C22.2 No 66
Frequency: 50/60 Hz
Thermal class: H
Insulation class: H
Ambient temperature: 40 °C*

Industrial control transformer suitable for installation in electric equipment manufactured according to UL 508A “Standard for industrial control panels”.

Vector group: available

XX letters in transformers part number are changed with two or three digit numbers, followed by UL or PF.UL. Those numbers identify customer finished product part number.

Transformer suitable to be customized with different voltages and regulation taps both at primary and secondary.

CODICE PART NUMBER	POTENZA POWER [kVA]	Larghezza Width A [mm]	Profondità Depth B [mm]	Altezza Height H [mm]	Fissaggio Fixing D [mm]	Fissaggio Fixing E [mm]	Peso Weight [kg]
TTH3.020000.XX.UL	20	480	340	480	425	204	140
TTH3.023000.XX.UL	23	480	350	480	425	214	155
TTH3.025000.XX.UL	25	480	360	480	425	224	165
TTH3.030000.XX.UL	30	480	370	480	425	234	174
TTH3.035000.XX.UL	35	600	375	600	550	190	185
TTH3.040000.XX.UL	40	600	385	600	550	200	200
TTH3.045000.XX.UL	45	600	395	600	550	210	220
TTH3.050000.XX.UL	50	600	405	600	550	220	240
TTH3.063000.XX.UL	63	600	425	600	550	240	270
TTH3.070000.XX.UL	70	600	445	600	550	260	310
TTH3.080000.XX.UL	80	600	475	600	550	270	360
TTH3.090000.XX.UL	90	600	475	600	550	270	360
TTH3.100000.XX.UL	100	680	560	680	470	320	420

TRASFORMATORI TRIFASE “UL LISTED” “UL LISTED” THREE-PHASE TRANSFORMERS

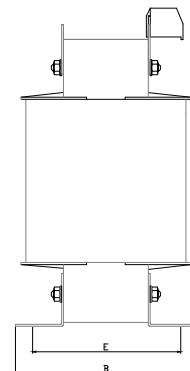
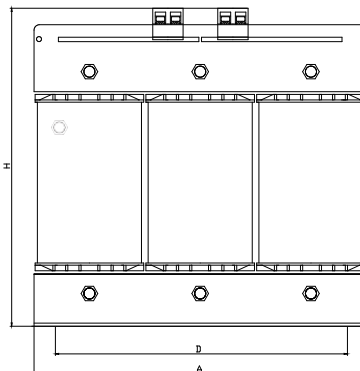

Trasformatore associato non resistente al cortocircuito
Trasformatore da incorporare in apparati elettrici specifici

Norme di riferimento: UL5085 e CSA C22.2 No 66
Frequenza: 50/60 Hz
Classe termica: F
Classe di isolamento: F
Temperatura ambiente 40 °C

Trasformatore di tipo “Industrial control” adatto anche ad essere installato in quadri elettrici costruiti in accordo alla norma UL 508A “Standard for industrial control panels”.

Gruppo vettoriale: a richiesta

Le lettere XX presenti nella codifica del trasformatore sono sostituite in fase d’ordine da un numero di due o tre cifre e seguite dalla dicitura UL o PF.UL. I numeri assegnati identificano univocamente il trasformatore ordinato.
Trasformatore personalizzabile con diverse tensioni e prese di regolazione sia al primario che al secondario.

*Associated transformer non-short-circuit proof
Transformer for special electric equipment*

*Reference standards: UL5085 and CSA C22.2 No 66
Frequency: 50/60 Hz
Thermal class: F
Insulation class: F
Ambient temperature: 40 °C*

Industrial control transformer suitable for installation in electric equipment manufactured according to UL508A “Standard for industrial control panels”.

Vector group: available

*XX letters in transformers part number are changed with two or three digit numbers, followed by UL or PF.UL. Those numbers will identify product.
Transformer suitable to be customized with different rated voltages and regulation taps both at primary and secondary end.*

TRASFORMATORI TRIFASE "UL LISTED" "UL LISTED" THREE-PHASE TRANSFORMERS

CODICE PART NUMBER	POTENZA POWER [kVA]	Larghezza Width A [mm]	Profondità Depth B [mm]	Altezza Height H [mm]	Fissaggio Fixing D [mm]	Fissaggio Fixing E [mm]	Peso Weight [kg]
TTF2.00500.XX.UL	0,5	180	115	200	150	81	9,1
TTF2.00630.XX.UL	0,63	180	120	200	150	86	9,6
TTF2.00800.XX.UL	0,8	180	120	200	150	86	10,2
TTF2.01000.XX.UL	1	180	130	200	150	96	12,0
TTF2.01300.XX.UL	1,3	240	130	250	200	87	17,8
TTF2.01600.XX.UL	1,6	240	130	250	200	87	18,9
TTF2.02000.XX.UL	2	240	140	250	200	97	23,1
TTF2.02200.XX.UL	2,2	240	140	250	200	97	23,6
TTF2.02500.XX.UL	2,5	300	150	300	250	112	28,8
TTF2.02800.XX.UL	2,8	300	150	300	250	112	30,4
TTF2.03000.XX.UL	3	300	160	300	250	122	35,6
TTF2.03200.XX.UL	3,2	300	160	300	250	122	36,1
TTF2.03500.XX.UL	3,5	300	160	300	250	122	37,1
TTF2.04000.XX.UL	4	300	160	300	250	122	38,1
TTF2.04500.XX.UL	4,5	300	170	300	250	132	43,3
TTF2.05000.XX.UL	5	300	180	300	250	142	52,4

TRASFORMATORI TRIFASE "UL LISTED" "UL LISTED" THREE-PHASE TRANSFORMERS

CODICE PART NUMBER	POTENZA POWER [kVA]	Larghezza Width A [mm]	Profondità Depth B [mm]	Altezza Height H [mm]	Fissaggio Fixing D [mm]	Fissaggio Fixing E [mm]	Peso Weight [kg]
TTF3.01000.XX.UL	1	180	130	200	150	96	12,0
TTF3.01300.XX.UL	1,3	240	130	250	200	97	17,8
TTF3.01600.XX.UL	1,6	240	130	250	200	97	18,9
TTF3.02000.XX.UL	2	240	140	250	200	112	23,1
TTF3.02200.XX.UL	2,2	300	150	300	250	112	28,8
TTF3.02500.XX.UL	2,5	300	150	300	250	122	28,8
TTF3.02800.XX.UL	2,8	300	150	300	250	132	30,4
TTF3.03000.XX.UL	3	300	160	300	250	142	35,6
TTF3.03200.XX.UL	3,2	300	160	300	250	142	36,1
TTF3.03500.XX.UL	3,5	300	160	300	250	142	37,1
TTF3.04000.XX.UL	4	300	160	300	250	152	38,1
TTF3.04500.XX.UL	4,5	300	170	300	250	162	43,3
TTF3.05000.XX.UL	5	360	170	350	325	135	48,6

TRASFORMATORI TRIFASE DI ISOLAMENTO PER IMPIANTI FOTOVOLTAICI ED EOLICI *THREE-PHASE ISOLATING TRANSFORMERS FOR PHOTOVOLTAIC AND WIND POWER SYSTEMS*



Trasformatore associato non resistente al corto circuito
Realizzazione a bassissime perdite ed elevato rendimento in servizio continuo

Norme di riferimento: EN 61558-2-4; EN 60076-11

Temperatura ambiente di progetto: + 45°C

Classe termica: B/F/H

Classe di isolamento: F/H

Materiale avvolgimenti: rame/alluminio

Frequenza: 50/60 Hz

Tensione primaria: 400 V

Tensione secondaria: 400 V

Gruppo vettoriale: YNyn0

Schermo elettrostatico

*Transformer non-short-circuit proof
High efficiency and very low losses design
specific for continuous operation*

Reference standards: EN 61558-2-4; EN 60076-11

Ambient temperature: + 45°C

Thermal class: B/F/H

Materials class: F/H

Winding materials: copper/aluminum

Frequency: 50/60Hz

Primary voltage: 400 V

Secondary voltage: 400 V

Vector Group: YNyn0

Screen between windings

64



ACCESSORI

Box metallico di protezione (IP23-44)

Sonde termiche PT100

Centralina per il controllo della temperatura

Terne di fusibili di protezione

Supporti antivibranti

Ruote di scorrimento orientabili

Kit di ventilazione forzata (solo in caso di box IP54)

ACCESSORIES

Metallic protection box (IP23-44)

PT100 temperature sensors

Temperature monitoring unit

Protection fuses

Antivibration supports

Sliding orientable wheels

Forced ventilation kit (only for IP54 box)

CODICE	POTENZA	ESECUZIONE IP00				PERDITE A PIENO CARICO			ESECUZIONE IN BOX IP23-44			
		IP00 EXECUTION				LOSSES UNDER 100% OF LOAD			BOX IP23-44 EXECUTION			
PART NUMBER	POWER [kVA]	Altezza Height H [mm]	Larghezza Width L [mm]	Profondità Depth P [mm]	Peso Weight [kg]	A vuoto No load [W]	A carico Under load [W]	Rendimento Efficiency [%]	Altezza Height H [mm]	Larghezza Width L [mm]	Profondità Depth P [mm]	Peso Weight [kg]
BTTTFV10	10	360	420	250	80	55	204	97,4				
BTTTFV12	12	360	420	270	100	63	238	97,5				
BTTTFV15	15	410	480	300	125	80	294	97,5	600	700	460	40
BTTTFV20	20	410	480	340	150	96	400	97,5				
BTTTFV25	25	410	480	360	170	141	458	97,6				
BTTTFV30	30	410	480	380	190	152	538	97,7				
BTTTFV35	35	470	540	330	210	161	648	97,7				
BTTTFV40	40	580	600	310	220	180	706	97,8				
BTTTFV50	50	580	600	330	260	212	831	97,9	800	900	650	70
BTTTFV60	60	580	600	360	290	236	1029	97,9				
BTTTFV70	70	600	600	400	310	275	1129	98,0				
BTTTFV80	80	600	600	440	330	296	1231	98,0				
BTTTFV90	90	580	640	440	360	331	1378	98,1				
BTTTFV100	100	580	660	460	400	356	1568	98,1				
BTTTFV110	110	580	690	460	420	395	1688	98,1				
BTTTFV120	120	650	690	460	460	421	1742	98,2				
BTTTFV130	130	650	700	460	480	455	1889	98,2				
BTTTFV150	150	680	750	460	520	488	2013	98,3	1000	1000	1000	100
BTTTFV200	200	680	750	550	610	541	2715	98,4				
BTTTFV250	250	700	750	630	730	639	3382	98,4				
BTTTFV300	300	820	850	630	850	783	3704	98,5				
BTTTFV400	400	820	890	650	1100	912	5012	98,5	1200	1200	1000	140
BTTTFV500	500	890	930	650	1300	1113	5831	98,6				

Note:
Tensioni differenti e gruppi vettoriali diversi rispetto a quelli indicati, sono realizzabili su richiesta. Colorazioni personalizzate del box di protezione sono fattibili su precisa indicazione.

Notes:
Different rated voltages and vector groups available on specific request. Different boxes colors are available under indication.

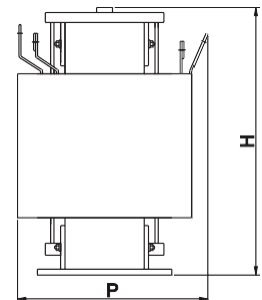
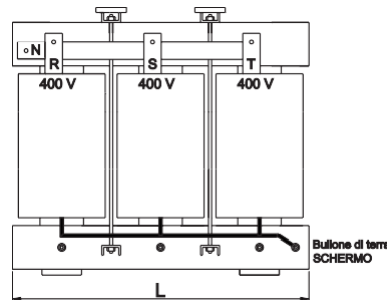
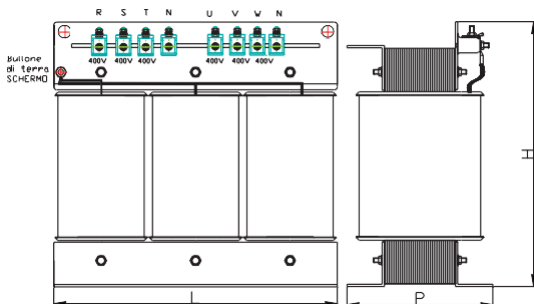
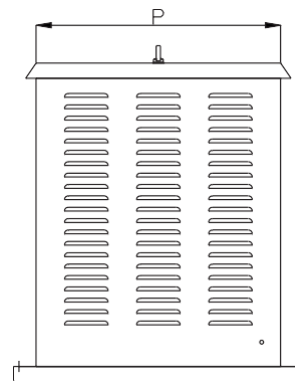
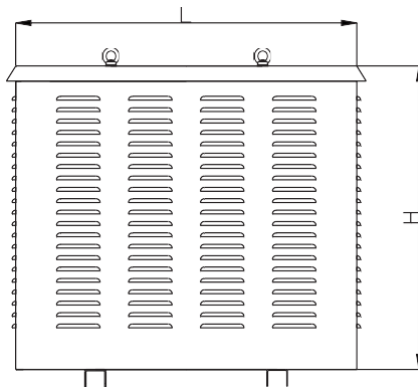

Fig. 1: Trasformatore trifase per fotovoltaico con uscite su morsetti a vite (per potenze fino a 80 kVA)

Fig. 2: Trasformatore trifase per fotovoltaico con uscite su barre in alluminio (per potenze superiori a 80 kVA)

Fig. 1: Three phase transformer with exits on screw clamps (up to 80 kVA rated power)

Fig. 2: Three phase transformer with exits on aluminum bars (over 80 kVA rated power)



TRASFORMATORI TRIFASE DI ISOLAMENTO PER IMPIANTI FOTOVOLTAICI ED EOLICI *THREE-PHASE ISOLATING TRANSFORMERS FOR PHOTOVOLTAIC AND WIND POWER SYSTEMS*



Trasformatore associato non resistente al corto circuito
Realizzazione a basse perdite ed elevato rendimento in servizio continuo

Norme di riferimento: EN 61558-2-4; EN 60076-11
Temperatura ambiente di progetto: + 45 °C
Classe termica: B/F/H
Classe di isolamento: F/H
Materiale avvolgimenti: rame/alluminio
Frequenza: 50/60 Hz
Tensione primaria: 400 V
Tensione secondaria: 400 V
Gruppo vettoriale: YNyn0

*Transformer non-short-circuit proof
High efficiency and low losses design specific for continuous operation*

*Reference standards: EN 61558-2-4; EN 60076-11
Ambient temperature: + 45 °C
Thermal class: B/F/H
Insulation class: F/H
Winding materials: copper/aluminum
Frequency: 50/60 Hz
Primary voltage: 400 V
Secondary voltage: 400 V
Vector Group: YNyn0*

66



ACCESSORI

Box metallico di protezione (IP23-44)
Sonde termiche PT100
Centralina T154 per il controllo della temperatura
Terne di fusibili di protezione
Supporti antivibranti
Ruote di scorrimento orientabili
Kit di ventilazione forzata (solo in caso di box IP54)

ACCESSORIES

*Metallic protection box (IP23-44)
PT100 temperature sensors
Temperature monitoring unit
Protection fuses
Antivibration supports
Sliding orientable wheels
Forced ventilation kit (only for IP54 box)*

CODICE PART NUMBER	POTENZA POWER [kVA]	ESECUZIONE IP00 IP00 EXECUTION				PERDITE A PIENO CARICO LOSSES UNDER 100% OF LOAD			ESECUZIONE IN BOX IP23-44 BOX IP23-44 EXECUTION			
		Altezza Height H [mm]	Larghezza Width L [mm]	Profondità Depth P [mm]	Peso Weight [kg]	A vuoto No load [W]	A carico Under load [W]	Rendi- mento Efficiency [%]	Altezza Height H [mm]	Larghezza Width L [mm]	Profondità Depth P [mm]	Peso Weight [kg]
BTTTFVS10	10	360	420	220	75	82	300	96,2	600	700	460	40
BTTTFVS12	12	360	420	250	93	95	360	96,2				
BTTTFVS15	15	360	420	280	115	120	420	96,4				
BTTTFVS20	20	410	480	250	140	140	580	96,4				
BTTTFVS25	25	410	480	300	160	205	670	96,5				
BTTTFVS30	30	410	480	340	175	220	800	96,6				
BTTTFVS35	35	410	480	350	195	240	950	96,6				
BTTTFVS40	40	470	540	320	205	280	1010	96,8				
BTTTFVS50	50	470	540	340	240	330	1180	97,0				
BTTTFVS60	60	470	540	360	270	365	1350	97,1				
BTTTFVS70	70	600	600	370	290	430	1460	97,3	800	900	650	70
BTTTFVS80	80	600	600	400	320	465	1630	97,4				
BTTTFVS90	90	600	600	430	335	490	1850	97,4				
BTTTFVS100	100	600	600	460	365	530	2100	97,4				
BTTTFVS110	110	580	620	450	370	590	2160	97,5				
BTTTFVS120	120	630	620	450	405	650	2230	97,6				
BTTTFVS130	130	630	620	480	425	690	2450	97,6				
BTTTFVS150	150	630	650	480	470	740	2720	97,7				
BTTTFVS200	200	720	680	520	590	965	3640	97,7				
BTTTFVS250	250	720	590	600	670	1090	4410	97,8				
BTTTFVS300	300	740	740	600	755	1210	5070	97,9	1000	1000	1000	100
BTTTFVS400	400	820	810	620	955	1610	5340	98,2				
BTTTFVS500	500	850	990	660	1100	1930	6960	98,2				

Note:

Tensioni differenti e gruppi vettoriali diversi rispetto a quelli indicati, sono realizzabili su richiesta. Colorazioni personalizzate del box di protezione sono fattibili su precisa indicazione.

Notes:

Different rated voltages and vector groups are available on specific request. Different boxes colors are available under indication.

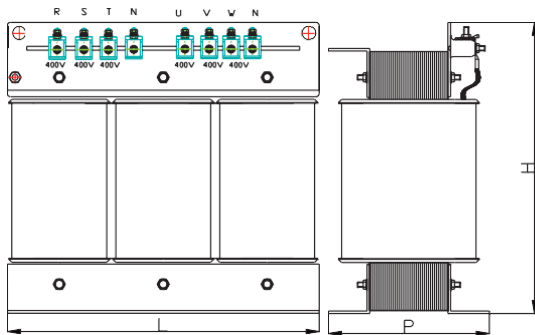

Fig. 1: Trasformatore trifase per fotovoltaico con uscite su morsetti a vite (per potenze fino a 100 kVA)

Fig. 2: Trasformatore trifase per fotovoltaico con uscite su barre in alluminio (per potenze superiori a 100 kVA)

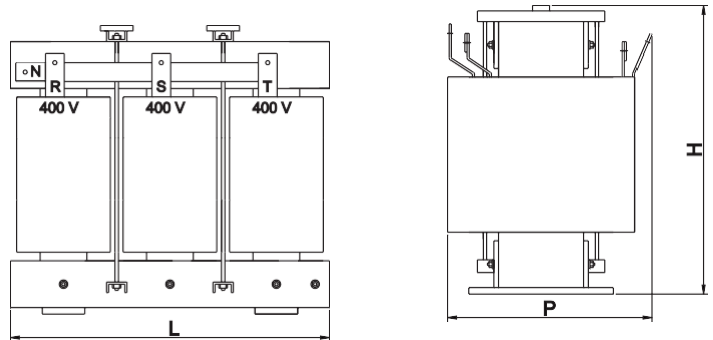
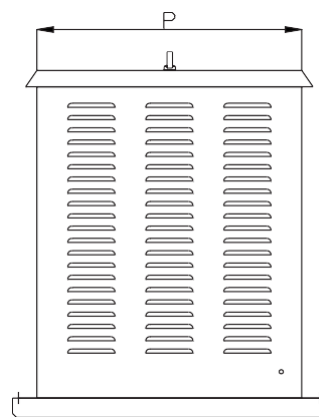
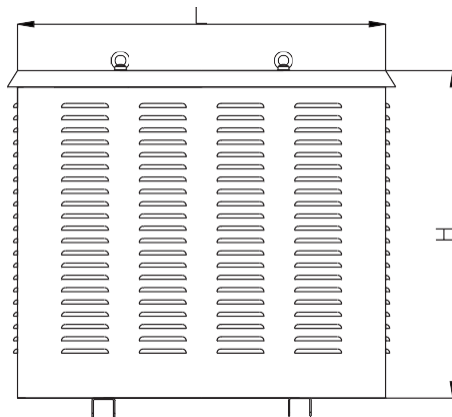

Fig. 1: Three phase transformer with exits on screw clamps (up to 100 kVA rated power)

Fig. 2: Three phase transformer with exits on aluminum bars (over 100 kVA rated power)



CARATTERISTICHE GENERALI GENERAL FEATURES

- Trasformatore non protetto contro i contatti diretti ed indiretti, destinato ad essere incorporato in incogniti equipaggiamenti elettrici;
- Trasformatore non protetto contro il cortocircuito;
- Grado di protezione contro i contatti diretti IP00 secondo le norme EN 60529;
- Trasformatore destinato ad una installazione fissa;
- Temperatura ambiente $-25\text{ °C} / +40\text{ °C}$
- Classe di sovratemperatura: B/F;
- Classe di isolamento: B/F;
- Costruzione secondo la norma EN 61558;
- Nucleo magnetico in lamierino al silicio a bassa cifra di perdita;
- Trasformatore tropicalizzato con vernici essiccanti in aria o a forno in classe H;
- Avvolgimenti in filo di rame o alluminio smaltato con resine in classe H (180 °C);
- Varie posizioni di montaggio permesse dalla particolare conformazione del supporto metallico;
- Materiale e componenti usati per la realizzazione del trasformatore sono certificati e conformi alle relative norme;
- **TUTTI I TRASFORMATORI POSSONO ESSERE COSTRUITI CON SISTEMA DI ISOLAMENTO OMOLOGATO UL SECONDO LA NORMA UL 1446 "Systems of insulating materials".**
- *Transformer not protected against direct and indirect contacts, intended to be incorporated in unknown electric equipment;*
- *Transformers non-short-circuit proof;*
- *IP00 protection degree against direct contacts according to EN 60529 standard;*
- *Transformer intended for fix installation;*
- *Ambient temperature: $-25\text{ °C} / +40\text{ °C}$*
- *Temperature class: B/F;*
- *Insulation class: B/F;*
- *EN 61558 manufacturing standards;*
- *Lamination core manufactured using silicon steel sheets characterized by low power losses;*
- *Transformers tropicalized by using H class varnish; drying process by natural air or by oven;*
- *H class (180 °C) magnetic copper or aluminium wire windings;*
- *Intended for different assembling layouts due to a big number of available metallic supports;*
- *Materials and components used for transformers manufacturing, are certified and conforming to their standards;*
- **ALL TRANSFORMERS MAY BE MANUFACTURED WITH UL HOMOLOGATED INSULATION SYSTEM ACCORDING TO UL 1446 STANDARD "Systems of insulating materials".**

NOTE NOTES

I trasformatori trimonofase, come suggerisce il nome stesso, hanno l'ingresso trifase e l'uscita monofase. Questa particolare conformazione si rende utile quando si deve alimentare un carico monofase ma si ha a disposizione una rete trifase.

Non è esecuzione molto comune di macchina e normalmente viene eseguita solo su specifica richiesta, normalmente ne viene sconsigliato l'uso in virtù degli squilibri che tale macchina può provocare.

Si ricorda che non è possibile l'utilizzo inverso, cioè utilizzare l'ingresso monofase per ottenere in uscita una tensione trifase.

Three-single-phase transformers, as the name suggests, have a three-phase input and single-phase output. This particular configuration is useful when it is necessary to supply a single-phase load but there is a three-phase-network only available.

Three-single-phase transformer is not a common machine and it is usually manufactured after specific customer request. Because of the electrical current unbalance that this machine may introduce in the network, use is not recommended.

We want to remember that it is not possible to reverse the use of this machine to obtain a three-phase output from a single phase input.

TRASFORMATORI TRIMONOFASE THREE-SINGLE-PHASE TRANSFORMERS

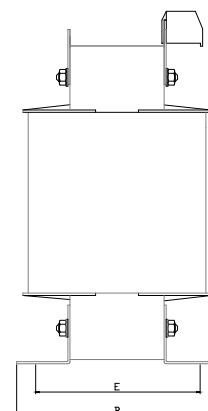
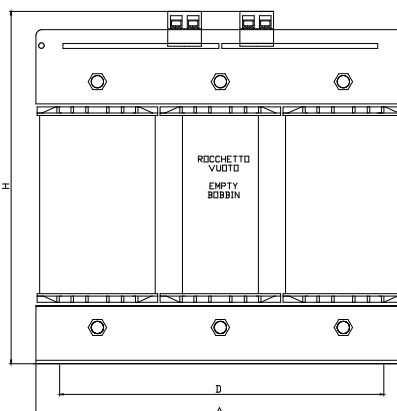

Trasformatore associato non resistente al cortocircuito
Trasformatore da incorporare in apparati elettrici specifici

*Associated transformer non-short-circuit proof
Transformer for special electric equipment*

Norme di riferimento: EN 61558-2-4

Frequenza: 50/60 Hz

Tensione primaria: 400 V

Tensione secondaria: 230 V

Reference standards: EN 61558-2-4

Frequency: 50/60 Hz

Primary voltage: 400 V

Secondary voltage: 230 V

CODICE PART NUMBER	POTENZA POWER [kVA]	Larghezza Width A [mm]	Profondità Depth B [mm]	Altezza Height H [mm]	Fissaggio Fixing D [mm]	Fissaggio Fixing E [mm]	Peso Weight [kg]
BTTR182	0,5	180	120	200	150	86	9,4
BTTR183	1	240	130	250	200	87	17,2
BTTR184	1,5	240	140	250	200	97	21,1
BTTR185	2	300	140	300	250	102	28,5
BTTR186	2,5	300	150	300	250	112	33,4
BTTR187	3	300	160	300	250	122	38,6
BTTR188	3,5	300	180	300	250	142	47,2
BTTR189	4	300	190	300	250	152	51,9
BTTR190	5	360	180	350	350	145	62,7
BTTR191	6	360	190	350	325	155	70,1
BTTR192	7	420	180	400	375	140	78,7
BTTR193	8	420	190	400	375	150	88,7
BTTR194	10	420	210	400	375	170	105,3
BTTR195	12	420	230	400	375	190	124,4
BTTR196	15	480	230	450	425	194	155,0
BTTR197	20	480	270	450	425	234	200,7
BTTR198	25	540	260	500	479	220	228,0
BTTR199	30	540	280	500	479	240	259,8

AUTOTRASFORMATORI

AUTOTRANSFORMERS

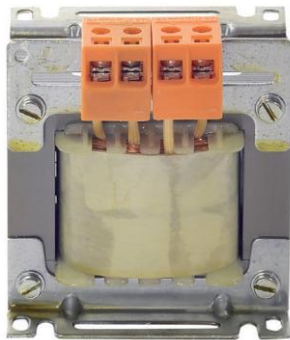
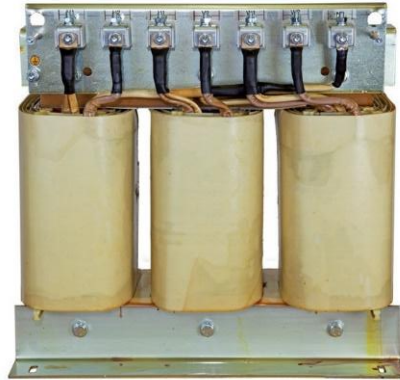

CARATTERISTICHE GENERALI GENERAL FEATURES

- Autotrasformatore non protetto contro i contatti diretti ed indiretti, destinato ad essere incorporato in incogniti equipaggiamenti elettrici;
- Autotrasformatore non protetto contro il cortocircuito;
- Grado di protezione contro i contatti diretti IP00 secondo le norme EN 60529;
- Autotrasformatore destinato ad una installazione fissa;
- Temperatura ambiente: $-25\text{ }^{\circ}\text{C} / +40\text{ }^{\circ}\text{C}$;
- Classe di sovratemperatura: B/F/H;
- Classe di isolamento: B/F/H;
- Costruzione secondo la norma EN 61558;
- Nucleo magnetico in lamierino al silicio a bassa cifra di perdita;
- Autotrasformatore tropicalizzato con vernici essicanti in aria o a forno in classe H;
- Avvolgimenti in filo di rame o alluminio smaltato con resine in classe H ($180\text{ }^{\circ}\text{C}$);
- Varie posizioni di montaggio permesse dalla particolare conformazione del supporto metallico;
- Materiale e componenti usati per la realizzazione dell'autotrasformatore sono certificati e conformi alle relative norme;
- Per quantitativi elevati, a richiesta del cliente, è possibile ottenere certificazioni di conformità di Istituti Europei e Nordamericani;
- **TUTTI GLI AUTOTRASFORMATORI POSSONO ESSERE COSTRUITI CON SISTEMA DI ISOLAMENTO OMOLOGATO UL SECONDO LA NORMA UL 1446 "Systems of insulating materials".**
- *Autotransformers not protected against direct and indirect contacts, intended to be incorporated in unknown electric equipment;*
- *Autotransformers non-short-circuit proof;*
- *IP00 protection degree against direct contacts according to EN 60529 standard;*
- *Autotransformers intended for fix installation;*
- *Ambient temperature: $-25\text{ }^{\circ}\text{C} / +40\text{ }^{\circ}\text{C}$;*
- *Temperature class: B/F;*
- *Insulation class: B/F;*
- *EN 61558 manufacturing standards;*
- *Lamination core manufactured using silicon steel sheets characterized by low power losses;*
- *Autotransformers tropicalized by using H class varnishes; drying process by natural air or by oven;*
- *H class ($180\text{ }^{\circ}\text{C}$) magnetic copper or aluminium wire windings;*
- *Intended for different assembling layouts due to a big number of available metallic brackets;*
- *Materials and components used for autotransformers manufacturing are certified and conforming to their standards;*
- *For high quantity supplies, under customer specific request, it is possible to obtain conformity certifications issued by the major European and North American institutes;*
- **ALL AUTOTRANSFORMERS MAY BE MANUFACTURED WITH UL HOMOLOGATED INSULATION SYSTEM ACCORDING TO UL 1446 STANDARD "Systems of insulating materials".**

SCelta DEI FUSIBILI DI PROTEZIONE E DISSIPAZIONE MASSIMA AID TABLE FOR FUSES CHOICE AND POWER DISSIPATION

POTENZA POWER [VA]	PRIMARIO O SECONDARIO (tensione di utilizzo) PRIMARY OR SECONDARY (operative voltage)						DISSIPAZIONE DISSIPATION [W]
	110 V	230 V	380 V	400 V	440 V	500 V	
50	1,25	0,5	0,315	0,315	0,315	0,25	3
100	2	1,25	0,63	0,63	0,5	0,5	6
200	2	2	1,25	1,25	1,25	1	12
300	4	2	1,6	1,6	1,6	1,6	17
400	4	2	2	2	2	1,6	23
500	6	4	2	2	2	2	29
600	6	4	2	2	2	2	35
800	8	4	4	2	2	2	46
1000	10	6	4	4	4	2	58
2000	20	10	6	6	6	4	115
3000	32	16	8	8	8	6	175
5000	50	25	16	16	16	10	290
8000	80	40	25	20	20	16	465
10000	100	50	35	25	25	20	580

- Si consiglia di utilizzare fusibili di tipo aM per la protezione dei circuiti in entrata e di tipo gG per la protezione dei circuiti di uscita (compatibilmente con il carico alimentato);
- Con sfondo evidenziato fusibili tipo 5x20 in vetro;
- Per la protezione possono essere utilizzati, in alternativa ai fusibili, anche interruttori automatici;
- I dispositivi di protezione devono essere conformi alle relative norme;
- La dissipazione si intende indicativa per il calcolo della temperatura all'interno di quadri elettrici;
- Per caratteristiche non comprese nella tabella applicare, per interpolazione, lo stesso principio di calcolo.

- *We suggest to use aM type fuses for input circuits protection and gG type for output circuits protection (according to the load);*
- *5x20 glass fuses highlighted in blue;*
- *Automatic switches in place of fuses, are also helpful for transformer protection;*
- *Protection devices must be conforming to their own standards;*
- *Dissipation values are indicative and useful only for temperature calculation inside electrical cabinet;*
- *For powers not included in the tab, it is possible to calculate them by interpolation.*

AUTOTRASFORMATORI MONOFASE SINGLE-PHASE AUTOTRANSFORMERS

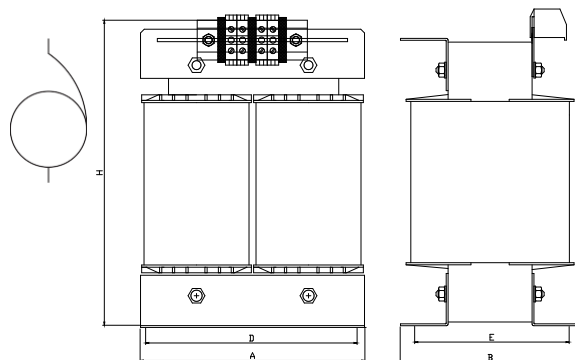
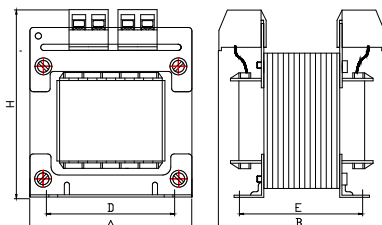
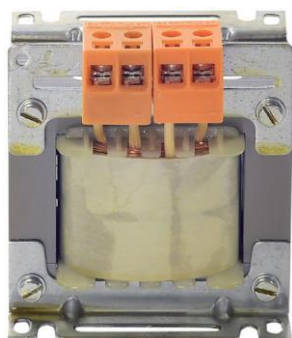

Autotrasformatore reversibile associato non resistente al cortocircuito
Autotrasformatore da incorporare in apparati elettrici specifici

*Associated reversible autotransformer non-short-circuit proof
Autotransformer for special electric equipment*

Norme di riferimento: EN 61558-2-13

Frequenza: 50/60 Hz

Tensione di lavoro: 0/230/400 V

Reference standards: EN 61558-2-13

Frequency: 50/60 Hz

Working voltage: 0/230/400 V

CODICE PART NUMBER	POTENZA POWER [VA]	Larghezza Width A [mm]	Profondità Depth B [mm]	Altezza Height H [mm]	Fissaggio Fixing D [mm]	Fissaggio Fixing E [mm]	Peso Weight [kg]
BTAM100	50	75	70	88	55	48	1,1
BTAM101	100	84	78	95	60	55	1,6
BTAM102	150	84	83	95	60	60	1,7
BTAM103	200	84	88	95	60	65	2,0
BTAM104	300	96	97	105	68	70	2,9
BTAM105	400	96	102	105	68	75	3,3
BTAM106	500	120	100	125	80	68	4,2
BTAM107	600	120	100	125	80	68	4,3
BTAM109	800	120	130	125	80	98	6,6
BTAM110	1000	120	140	125	80	108	7,7
BTAM111	1500	150	150	150	105	110	11,8
BTAM112	2000	150	150	150	105	110	12,7
BTAM113	2500	150	160	150	105	120	13,9
BTAM114	3000	150	170	150	105	130	15,5
BTAM115	4000	180	170	175	130	128	20,4
BTAM116	5000	192	184	185	145	139	25,3
BTAM117	6000	192	204	235	145	159	30,4
BTAM118	7000	192	214	235	145	169	33,0
BTAM119	8000	240	190	275	210	136	37,0
BTAM120	10000	240	210	275	210	156	44,4
BTAM121	12000	240	220	275	210	166	48,8
BTAM122	16000	240	250	275	210	196	59,6
BTAM123	20000	280	190	430	234	146	60,7
BTAM124	25000	280	200	430	234	156	68,2
BTAM125	30000	280	210	430	234	166	74,2

Per potenze superiori a 8 kVA,
esecuzione su due colonne

*For transformers over 8 kVA,
production coil type*

AUTOTRASFORMATORI MONOFASE SINGLE-PHASE AUTOTRANSFORMERS

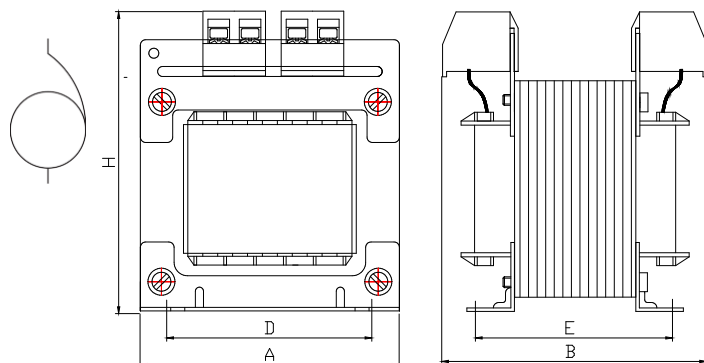
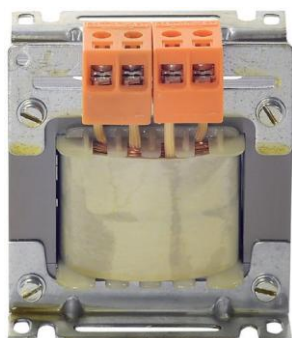

Autotrasformatore reversibile associato non resistente al cortocircuito
Autotrasformatore da incorporare in apparati elettrici specifici

Norme di riferimento: EN 61558-2-13
Frequenza: 50/60 Hz
Classe termica e d'isolamento: F
Temperatura ambiente: 40 °C
Tensione di lavoro: 0/125/230/400 V

*Associated reversible autotransformer non-short-circuit proof
Transformer for special electric equipment*

*Reference standards: EN 61558-2-13
Frequency: 50/60 Hz
Thermal & insulation class: F
Ambient temperature: 40 °C
Working voltage: 0/125/230/400 V*

CODICE PART NUMBER	POTENZA POWER [VA]	Larghezza Width A [mm]	Profondità Depth B [mm]	Altezza Height H [mm]	Fissaggio Fixing D [mm]	Fissaggio Fixing E [mm]	Peso Weight [kg]
BTAM100125	50	75	70	88	55	48	1,1
BTAM101125	100	84	78	95	60	55	1,6
BTAM102125	150	96	87	105	68	60	2,5
BTAM103125	200	96	92	105	68	65	2,7
BTAM104125	300	96	102	105	68	75	3,3
BTAM105125	400	120	100	125	80	68	4,3
BTAM106125	500	120	115	125	80	83	5,7
BTAM107125	600	120	125	125	80	93	6,6
BTAM109125	800	120	130	125	80	98	7,1
BTAM110125	1000	150	130	150	105	90	9,7
BTAM111125	1500	150	170	150	105	130	15,4
BTAM112125	2000	180	160	175	130	118	18,3
BTAM113125	2500	180	160	175	130	118	18,9
BTAM114125	3000	180	180	175	130	138	22,8
BTAM115125	4000	192	224	210	145	173	35,2
BTAM116125	5000	240	190	250	210	136	38,3

AUTOTRASFORMATORI MONOFASE SINGLE-PHASE AUTOTRANSFORMERS

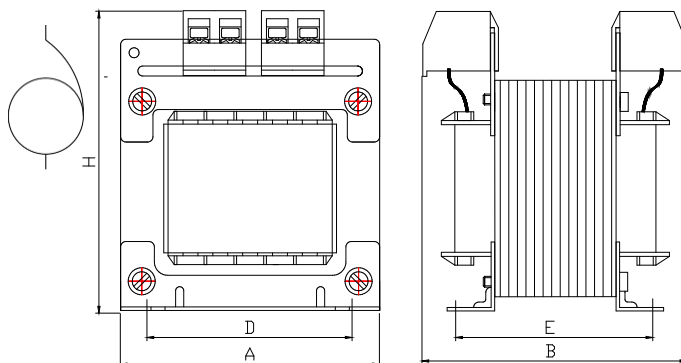
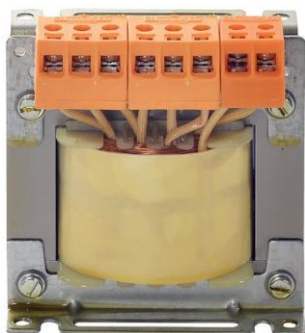

Autotrasformatore associato non resistente al cortocircuito
Autotrasformatore da incorporare in apparati elettrici specifici

*Associated autotransformer non-short-circuit proof
Autotransformer for special electric equipment*

Norme di riferimento: EN 61558-2-13

Frequenza: 50/60 Hz

Classe termica e d'isolamento: F

Temperatura ambiente: 40 °C

Tensione di lavoro: 0/110/125/160/230/260/400 V

Reference standards: EN 61558-2-13

Frequency: 50/60 Hz

Thermal & insulation class: F

Ambient temperature: 40 °C

Working voltage: 0/110/125/160/230/260/400 V

CODICE PART NUMBER	POTENZA POWER [VA]	Larghezza Width A [mm]	Profondità Depth B [mm]	Altezza Height H [mm]	Fissaggio Fixing D [mm]	Fissaggio Fixing E [mm]	Peso Weight [kg]
BTAM100MULTIP	50	75	70	88	55	48	1,1
BTAM101MULTIP	100	84	78	95	60	55	1,6
BTAM102MULTIP	150	96	87	105	68	60	2,5
BTAM103MULTIP	200	96	92	105	68	65	2,8
BTAM104MULTIP	300	96	102	105	68	75	3,2
BTAM105MULTIP	400	120	100	125	80	68	4,3
BTAM106MULTIP	500	120	115	125	80	83	5,7
BTAM107MULTIP	600	120	120	125	80	88	6,3
BTAM109MULTIP	800	120	130	125	80	98	7,1
BTAM110MULTIP	1000	150	130	150	105	90	9,8
BTAM111MULTIP	1500	150	150	150	105	110	12,8
BTAM112MULTIP	2000	180	150	175	130	108	16,6
BTAM113MULTIP	2500	180	160	200	130	118	19,0
BTAM114MULTIP	3000	192	194	210	145	149	28,0
BTAM115MULTIP	4000	192	214	210	145	169	33,0
BTAM116MULTIP	5000	192	234	210	145	189	37,7

AUTOTRASFORMATORI MONOFASE "UL RECOGNIZED" "UL RECOGNIZED" SINGLE-PHASE AUTOTRANSFORMERS

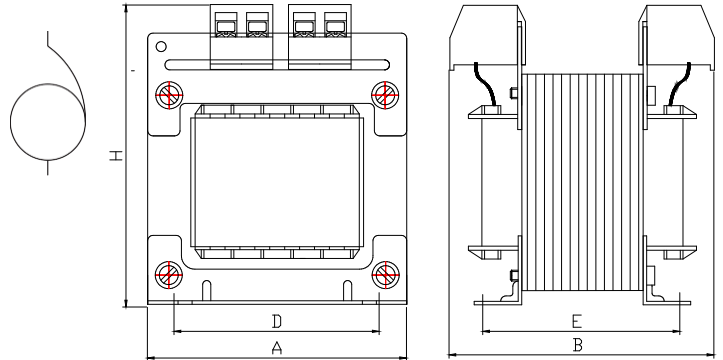
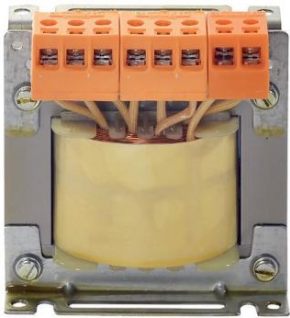

Autotrasformatore associato non resistente al cortocircuito
Autotrasformatore da incorporare in apparati elettrici specifici

Associated autotransformer non-short-circuit proof
Autotransformer for special electric equipment

Norme di riferimento: UL5085 e CSA C22.2 No 66
Frequenza: 50/60 Hz
Classe termica e d'isolamento: F
Temperatura ambiente: 40 °C

Reference standards: UL5085 and CSA C22.2 No 66
Frequency: 50/60 Hz
Thermal & insulation class: F
Ambient temperature: 40 °C

76

Trasformatore "Industrial control" adatto anche ad essere installato in quadri elettrici costruiti in accordo alla norma UL 508A "Standard for industrial control panels".

Industrial control transformer suitable for installation in electric equipment manufactured according to UL 508A "Standard for industrial control panels".

CODICE PART NUMBER	POTENZA DI NUCLEO CORE POWER [VA]	Larghezza Width A [mm]	Profondità Depth B [mm]	Altezza Height H [mm]	Fissaggio Fixing D [mm]	Fissaggio Fixing E [mm]	Peso Weight [kg]
AMF2.00030.XX.UL	30	75	75	88	55	53	1,2
AMF2.00050.XX.UL	50	84	78	95	60	55	1,5
AMF2.00075.XX.UL	75	84	83	95	60	60	1,8
AMF2.00080.XX.UL	80	96	84	105	68	57	2,1
AMF2.00100.XX.UL	100	96	87	105	68	60	2,3
AMF2.00150.XX.UL	150	96	97	105	68	70	2,9
AMF2.00160.XX.UL	160	96	102	105	68	75	3,2
AMF2.00200.XX.UL	200	108	106	115	75	79	4,0
AMF2.00250.XX.UL	250	120	100	125	80	74	4,6
AMF2.00300.XX.UL	300	120	110	125	80	84	5,3
AMF2.00320.XX.UL	320	120	115	125	80	89	5,6
AMF2.00400.XX.UL	400	120	125	125	80	99	6,6
AMF2.00500.XX.UL	500	135	125	138	110	88	7,9
AMF2.00600.XX.UL	600	150	130	150	105	90	9,8
AMF2.00630.XX.UL	630	150	140	150	105	100	10,6
AMF2.00700.XX.UL	700	150	150	150	105	110	11,8
AMF2.00800.XX.UL	800	150	160	150	105	120	13,8
AMF2.01000.XX.UL	1000	180	140	175	130	98	14,6
AMF2.01200.XX.UL	1200	180	150	175	130	108	16,5
AMF2.01300.XX.UL	1300	180	160	175	130	118	18,5
AMF2.01500.XX.UL	1500	180	170	175	130	128	20,7
AMF2.01600.XX.UL	1600	192	174	185	160	128	23,8
AMF2.02000.XX.UL	2000	192	184	185	160	138	25,9
AMF2.02200.XX.UL	2200	192	204	185	160	158	30,1
AMF2.02500.XX.UL	2500	192	214	185	160	168	33,0
AMF2.03000.XX.UL	3000	192	234	185	160	188	37,6
AMF2.03200.XX.UL	3200	240	200	225	210	146	40,1
AMF2.04000.XX.UL	4000	240	220	225	210	166	48,6
AMF2.05000.XX.UL	5000	240	210	350	205	144	49,5
AMF2.06000.XX.UL	6000	240	220	350	205	154	50,4
AMF2.06300.XX.UL	6300	280	210	400	234	136	55,2
AMF2.07000.XX.UL	7000	280	220	400	234	146	62,0
AMF2.10000.XX.UL	10000	280	250	400	234	176	80,9
AMF2.11000.XX.UL	11000	280	260	400	234	186	87,7
AMF2.13000.XX.UL	13000	320	260	450	264	197	98,5

AUTOTRASFORMATORI MONOFASE "UL RECOGNIZED" "UL RECOGNIZED" SINGLE-PHASE AUTOTRANSFORMERS

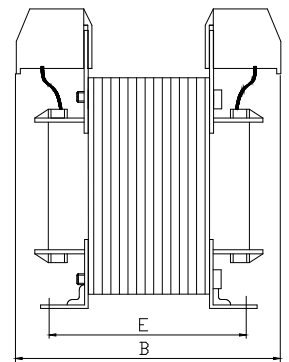
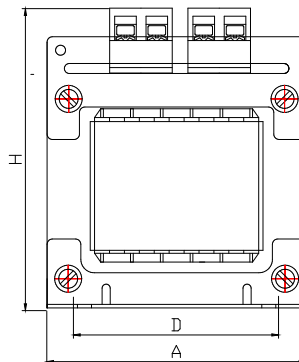
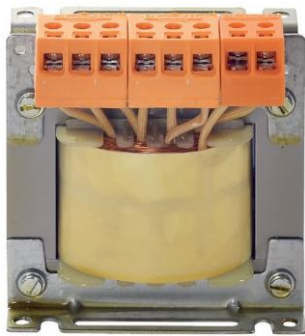

Autotrasformatore associato non resistente al cortocircuito
Autotrasformatore da incorporare in apparati elettrici specifici

*Associated autotransformer non-short-circuit proof
Autotransformer for special electric equipment*

Norme di riferimento: UL5085 e CSA C22.2 No 66
Frequenza: 50/60 Hz
Classe termica e d'isolamento: F
Temperatura ambiente: 40 °C

*Reference standards: UL5085 and CSA C22.2 No 66
Frequency: 50/60 Hz
Thermal & insulation class: F
Ambient temperature: 40 °C*

Trasformatore "Industrial control" adatto anche ad essere installato in quadri elettrici costruiti in accordo alla norma UL 508A "Standard for industrial control panels".

Industrial control transformer suitable for installation in electric equipment manufactured according to UL 508A "Standard for industrial control panels".

CODICE PART NUMBER	POTENZA DI NUCLEO CORE POWER [VA]	Larghezza Width A [mm]	Profondità Depth B [mm]	Altezza Height H [mm]	Fissaggio Fixing D [mm]	Fissaggio Fixing E [mm]	Peso Weight [kg]
AMF3.00600.XX.UL	600	150	160	150	105	120	13,8
AMF3.00630.XX.UL	630	150	160	150	105	120	14,0
AMF3.00700.XX.UL	700	180	140	175	130	98	14,6
AMF3.00800.XX.UL	800	180	160	175	130	118	15,0
AMF3.01000.XX.UL	1000	192	150	185	160	104	23,8
AMF3.01200.XX.UL	1200	192	156	185	160	110	24,5
AMF3.01300.XX.UL	1300	192	176	185	160	130	25,5
AMF3.01500.XX.UL	1500	192	186	185	160	140	26,0
AMF3.01600.XX.UL	1600	192	186	185	160	140	26,3
AMF3.02000.XX.UL	2000	192	206	185	160	160	27,0
AMF3.02200.XX.UL	2200	192	236	185	160	190	30,1
AMF3.02500.XX.UL	2500	192	236	185	160	190	31,0
AMF3.03000.XX.UL	3000	240	200	225	210	146	40,1
AMF3.03200.XX.UL	3200	240	220	225	210	166	41,1
AMF3.04000.XX.UL	4000	240	230	225	210	176	44,6
AMF3.05000.XX.UL	5000	240	220	350	205	154	49,5
AMF3.06000.XX.UL	6000	280	210	400	214	154	50,4
AMF3.06300.XX.UL	6300	280	260	400	234	184	55,2
AMF3.07000.XX.UL	7000	320	220	450	264	146	62,0
AMF3.10000.XX.UL	10000	320	230	450	264	156	80,9
AMF3.11000.XX.UL	11000	320	240	450	264	166	87,7
AMF3.13000.XX.UL	13000	320	260	450	264	186	98,5

AUTOTRASFORMATORI MONOFASE "UL LISTED" "UL LISTED" SINGLE-PHASE AUTOTRANSFORMERS

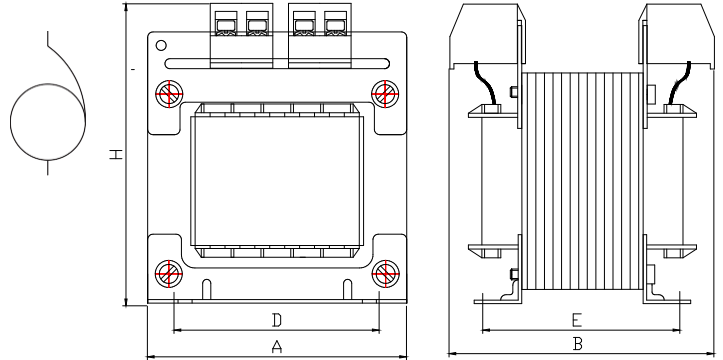
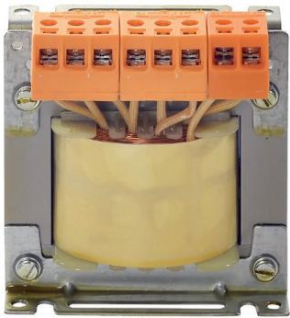

Autotrasformatore associato non resistente al cortocircuito
Autotrasformatore da incorporare in apparati elettrici specifici

*Associated autotransformer non-short-circuit proof
Autotransformer for special electric equipment*

Norme di riferimento: UL5085 e CSA C22.2 No 66
Frequenza: 50/60 Hz
Classe termica e d'isolamento: F
Temperatura ambiente: 40 °C

*Reference standards: UL5085 and CSA C22.2 No 66
Frequency: 50/60 Hz
Thermal & insulation class: F
Ambient temperature: 40 °C*

Trasformatore "Industrial control" adatto anche ad essere installato in quadri elettrici costruiti in accordo alla norma UL 508A "Standard for industrial control panels".

Industrial control transformer suitable for installation in electric equipment manufactured according to UL 508A "Standard for industrial control panels".

CODICE PART NUMBER	POTENZA DI NUCLEO CORE POWER [VA]	Larghezza Width A [mm]	Profondità Depth B [mm]	Altezza Height H [mm]	Fissaggio Fixing D [mm]	Fissaggio Fixing E [mm]	Peso Weight [kg]
AML2.00030.XX.UL	30	75	75	88	55	53	1,2
AML2.00050.XX.UL	50	84	78	95	60	55	1,5
AML2.00075.XX.UL	75	84	83	95	60	60	1,8
AML2.00080.XX.UL	80	96	84	105	68	57	2,1
AML2.00100.XX.UL	100	96	87	105	68	60	2,3
AML2.00150.XX.UL	150	96	97	105	68	70	2,9
AML2.00160.XX.UL	160	96	102	105	68	75	3,2
AML2.00200.XX.UL	200	108	106	115	75	79	4,0
AML2.00250.XX.UL	250	120	100	125	80	74	4,6
AML2.00300.XX.UL	300	120	110	125	80	84	5,3
AML2.00320.XX.UL	320	120	115	125	80	89	5,6
AML2.00400.XX.UL	400	120	125	125	80	99	6,6
AML2.00500.XX.UL	500	135	125	138	110	88	7,9
AML2.00600.XX.UL	600	150	130	150	105	90	9,8
AML2.00630.XX.UL	630	150	140	150	105	100	10,6
AML2.00700.XX.UL	700	150	150	150	105	110	11,8
AML2.00800.XX.UL	800	150	160	150	105	120	13,8
AML2.01000.XX.UL	1000	180	140	175	130	98	14,6
AML2.01200.XX.UL	1200	180	150	175	130	108	16,5
AML2.01300.XX.UL	1300	180	160	175	130	118	18,5
AML2.01500.XX.UL	1500	180	170	175	130	128	20,7
AML2.01600.XX.UL	1600	192	174	185	160	128	23,8
AML2.02000.XX.UL	2000	192	184	185	160	138	25,9
AML2.02200.XX.UL	2200	192	204	185	160	158	30,1
AML2.02500.XX.UL	2500	192	214	185	160	168	33,0
AML2.03000.XX.UL	3000	192	234	185	160	188	37,6
AML2.03200.XX.UL	3200	240	200	225	210	146	40,1
AML2.04000.XX.UL	4000	240	220	225	210	166	48,6

AUTOTRASFORMATORI MONOFASE “UL LISTED” “UL LISTED” SINGLE-PHASE AUTOTRANSFORMERS

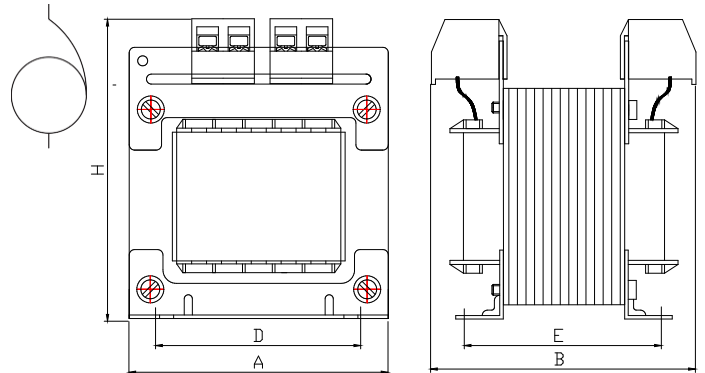
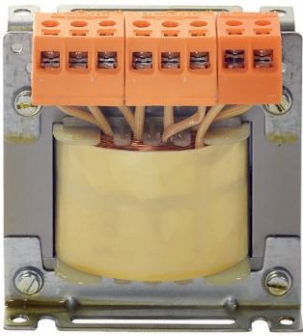

Autotrasformatore associato non resistente al cortocircuito
Autotrasformatore da incorporare in apparati elettrici specifici

Norme di riferimento: UL5085 e CSA C22.2 No 66
Frequenza: 50/60 Hz
Classe termica e d'isolamento: F
Temperatura ambiente: 40 °C

Trasformatore “Industrial control” adatto anche ad essere installato in quadri elettrici costruiti in accordo alla norma UL 508A “Standard for industrial control panels”.

*Associated autotransformer non-short-circuit proof
Autotransformer for special electric equipment*

*Reference standards: UL5085 and CSA C22.2 No 66
Frequency: 50/60 Hz
Thermal & insulation class: F
Ambient temperature: 40 °C*

Industrial control transformer suitable for installation in electric equipment manufactured according to UL 508A “Standard for industrial control panels”.

CODICE PART NUMBER	POTENZA DI NUCLEO CORE POWER [VA]	Larghezza Width A [mm]	Profondità Depth B [mm]	Altezza Height H [mm]	Fissaggio Fixing D [mm]	Fissaggio Fixing E [mm]	Peso Weight [kg]
AML3.00600.XX.UL	600	150	160	150	105	120	13,8
AML3.00630.XX.UL	630	150	160	150	105	120	14,0
AML3.00700.XX.UL	700	180	140	175	130	98	14,6
AML3.00800.XX.UL	800	180	160	175	130	118	15,0
AML3.01000.XX.UL	1000	192	150	185	160	104	23,8
AML3.01200.XX.UL	1200	192	156	185	160	110	24,5
AML3.01300.XX.UL	1300	192	176	185	160	130	25,5
AML3.01500.XX.UL	1500	192	186	185	160	140	26,0
AML3.01600.XX.UL	1600	192	186	185	160	140	26,3
AML3.02000.XX.UL	2000	192	206	185	160	160	27,0
AML3.02200.XX.UL	2200	192	236	185	160	190	30,1
AML3.02500.XX.UL	2500	192	236	185	160	190	31,0
AML3.03000.XX.UL	3000	240	200	225	210	146	40,1
AML3.03200.XX.UL	3200	240	220	225	210	166	41,1
AML3.04000.XX.UL	4000	240	230	225	210	176	44,6

CARATTERISTICHE GENERALI GENERAL FEATURES

- Autotrasformatore non protetto contro i contatti diretti ed indiretti, destinato ad essere incorporato in incogniti equipaggiamenti elettrici;
 - Autotrasformatore non protetto contro il cortocircuito;
 - Grado di protezione contro i contatti diretti IP00 secondo le norme EN 60529;
 - Autotrasformatore destinato ad una installazione fissa;
 - Temperatura ambiente: -25 °C / +40 °C;
 - Classe di sovratemperatura: B/F/H;
 - Classe di isolamento: B/F/H;
 - Costruzione secondo la norma EN 61558;
 - Nucleo magnetico in lamierino al silicio a bassa cifra di perdita;
 - Autotrasformatore tropicalizzato con vernici essiccanti in aria o a forno in classe H;
 - Avvolgimenti in filo di rame o alluminio smaltato con resine in classe H (180 °C);
 - Varie posizioni di montaggio permesse dalla particolare conformazione del supporto metallico;
 - Materiale e componenti usati per la realizzazione dell'autotrasformatore sono certificati e conformi alle relative norme;
 - Per quantitativi elevati, a richiesta del cliente, è possibile ottenere certificazioni di conformità di Istituti Europei e Nordamericani;
 - **TUTTI GLI AUTOTRASFORMATORI POSSONO ESSERE COSTRUITI CON SISTEMA DI ISOLAMENTO OMOLOGATO UL SECONDO LA NORMA UL 1446 "Systems of insulating materials".**
- *Autotransformers not protected against direct and indirect contacts, intended to be incorporated in unknown electric equipment;*
 - *Autotransformers non-short-circuit proof;*
 - *IP00 protection degree against direct contacts according to EN 60529 standard;*
 - *Autotransformers intended for fix installation;*
 - *Ambient temperature: -25 °C / +40 °C;*
 - *Temperature class: B/F/H;*
 - *Insulation class: B/F/H;*
 - *EN 61558 manufacturing standards;*
 - *Lamination core manufactured using silicon steel sheets characterized by low power losses;*
 - *Autotransformers tropicalized by using H class varnish; drying process by natural air or by oven;*
 - *H class (180 °C) magnetic copper or aluminium wire windings;*
 - *Intended for different assembling layouts due to a big number of available metallic supports;*
 - *Materials and components used for autotransformer manufacturing are certified and conforming to their standards;*
 - *For high quantity supplies, under customer specific request, it is possible to obtain conformity certifications issued by the major European and North American institutes;*
 - **ALL AUTOTRANSFORMERS MAY BE MANUFACTURED WITH UL HOMOLOGATED INSULATION SYSTEM ACCORDING TO UL 1446 STANDARD "Systems of insulating materials".**

SCelta DEI FUSIBILI DI PROTEZIONE E DISSIPAZIONE MASSIMA AID TABLE FOR FUSES CHOICE AND POWER DISSIPATION

POTENZA POWER [kVA]	PRIMARIO O SECONDARIO (tensione di utilizzo) PRIMARY OR SECONDARY (operative voltage)						DISSIPAZIONE DISSIPATION [W]
	110 V	230 V	380 V	400 V	440 V	500 V	
1	6	4	2	2	2	2	55
2	16	6	4	4	4	4	110
3	16	8	6	6	4	4	170
5	32	16	8	8	8	6	280
8	50	25	16	16	16	10	450
10	63	32	16	16	16	16	550
15	80	40	25	25	20	20	850
20	125	63	32	32	32	25	1100
30	160	80	50	50	40	40	1600
40	250	100	63	63	63	50	2250
50	315	125	80	80	80	63	2800
60	355	160	100	100	80	80	3350
80	500	250	125	125	125	100	4500
100	630	315	160	160	160	125	5500

- Si consiglia di utilizzare fusibili di tipo aM per la protezione dei circuiti in entrata e di tipo gG per la protezione dei circuiti di uscita (compatibilmente con il carico alimentato);
- Per la protezione possono essere utilizzati, in alternativa ai fusibili, anche interruttori automatici;
- I dispositivi di protezione devono essere conformi alle relative norme;
- La dissipazione si intende indicativa per il calcolo della temperatura all'interno di quadri elettrici;
- Per caratteristiche non comprese nella tabella applicare, per interpolazione, lo stesso principio di calcolo.

- *We suggest to use aM type fuses for input circuits protection and gG type for output circuits protection (according to the load);*
- *Automatic switches in place of fuses, are also helpful for transformer protection;*
- *Protection devices must be conforming to their own standards;*
- *Dissipation values are indicative and useful only for temperature calculation inside electrical cabinet;*
- *For powers not included in the above tab, it is possible to calculate them by interpolation.*

AUTOTRASFORMATORI TRIFASE THREE-PHASE AUTOTRANSFORMERS

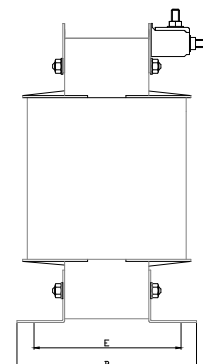
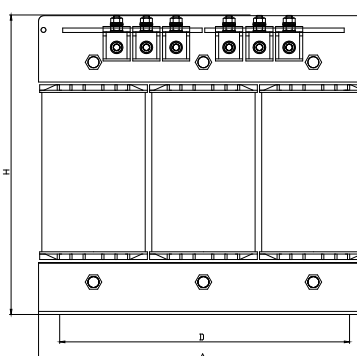

Autotrasformatore reversibile associato non resistente al cortocircuito
Autotrasformatore da incorporare in apparati elettrici specifici

Norme di riferimento: EN 61558-2-13, EN 60076-11
Frequenza: 50/60 Hz
Classe termica e d'isolamento: F
Temperatura ambiente: 40 °C
Tensione di lavoro: 230/400 V
Centro stella con neutro accessibile

*Associated reversible autotransformer non-short-circuit proof
Transformer for special electric equipment*

*Reference standards: EN 61558-2-13, EN 60076-11
Frequency: 50/60 Hz
Thermal & insulation class: F
Ambient temperature: 40 °C
Working voltage: 230/400 V
Available neutral terminal*

CODICE PART NUMBER	POTENZA POWER [kVA]	Larghezza Width A [mm]	Profondità Depth B [mm]	Altezza Height H [mm]	Fissaggio Fixing D [mm]	Fissaggio Fixing E [mm]	Peso Weight [kg]
BTAT206	0,5	150	105	175	125	69	5,2
BTAT207	1	180	105	200	150	71	7,0
BTAT208	1,5	180	115	200	150	81	9,0
BTAT209	2	180	120	200	150	86	10,4
BTAT210	2,5	180	125	200	150	91	11,3
BTAT211	3	240	120	250	200	77	15,6
BTAT212	4	240	130	250	200	87	19,1
BTAT213	5	240	140	250	200	97	21,4
BTAT214	6	240	140	250	200	97	22,6
BTAT215	8	300	160	300	250	122	38,9
BTAT216	10	300	170	300	250	132	42,5
BTAT217	12	300	180	300	250	142	49,9
BTAT218	15	360	180	350	325	145	61,8
BTAT219	20	360	190	350	325	155	75,4
BTAT220	25	420	200	400	375	160	96,5
BTAT221	30	420	210	400	375	170	107,7
BTAT222	40	420	220	400	375	180	123,3
BTAT223	50	480	240	450	425	204	176,5
BTAT224	60	480	250	450	425	214	180,1
BTAT226	80	480	270	450	425	234	219,6
BTAT227	100	540	260	500	479	220	244,4
BTAT228	125	540	270	500	479	230	267,3
BTAT229	150	540	280	500	479	240	279,8
BTAT230	200	540	280	500	479	240	282,0

AUTOTRASFORMATORI TRIFASE "UL RECOGNIZED" "UL RECOGNIZED" THREE-PHASE AUTOTRANSFORMERS

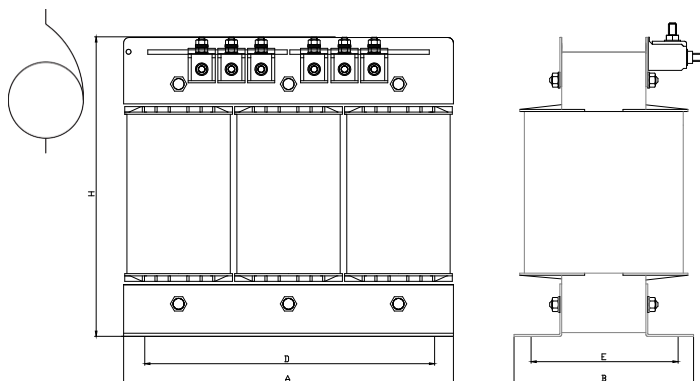

Autotrasformatore associato non resistente al cortocircuito
Autotrasformatore da incorporare in sistemi elettrici speciali

*Associated autotransformer non-short-circuit proof
Transformer for special electric equipment*

Norme di riferimento: EN 61558-2-13, EN 60076-11

Frequenza: 50/60 Hz

Classe termica e d'isolamento: F

Temperatura ambiente: 40 °C

Tensione di lavoro: 230/400 V

Centro stella con neutro accessibile

Reference standards: EN 61558-2-13, EN 60076-11

Frequency: 50/60 Hz

Thermal & insulation class: F

Ambient temperature: 40 °C

Working voltage: 230/400 V

Available neutral terminal

CODICE PART NUMBER	POTENZA DI NUCLEO CORE POWER [kVA]	Larghezza Width A [mm]	Profondità Depth B [mm]	Altezza Height H [mm]	Fissaggio Fixing D [mm]	Fissaggio Fixing E [mm]	Peso Weight [kg]
ATF2.00500.XX.UL	0,5	180	115	200	150	81	9,1
ATF2.00630.XX.UL	0,63	180	120	200	150	86	9,6
ATF2.00800.XX.UL	0,8	180	120	200	150	86	10,2
ATF2.01000.XX.UL	1	180	130	200	150	96	12,0
ATF2.01300.XX.UL	1,3	240	130	250	200	87	17,8
ATF2.01600.XX.UL	1,6	240	130	250	200	87	18,9
ATF2.02000.XX.UL	2	240	140	250	200	97	23,1
ATF2.02200.XX.UL	2,2	240	140	250	200	97	23,6
ATF2.02500.XX.UL	2,5	300	150	300	250	112	28,8
ATF2.02800.XX.UL	2,8	300	150	300	250	112	30,4
ATF2.03000.XX.UL	3	300	160	300	250	122	35,6
ATF2.03200.XX.UL	3,2	300	160	300	250	122	36,1
ATF2.03500.XX.UL	3,5	300	160	300	250	122	37,1
ATF2.04000.XX.UL	4	300	160	300	250	122	38,1
ATF2.04500.XX.UL	4,5	300	170	300	250	132	43,3
ATF2.05000.XX.UL	5	300	180	300	250	142	52,4
ATF2.05500.XX.UL	5,5	360	170	350	325	135	48,6
ATF2.06000.XX.UL	6	360	180	350	325	145	66,4
ATF2.06300.XX.UL	6,3	360	180	350	325	145	67,9
ATF2.07000.XX.UL	7	360	190	350	325	155	73,2
ATF2.08000.XX.UL	8	420	180	400	375	140	84,2
ATF2.09000.XX.UL	9	420	190	400	375	150	87,8
ATF2.10000.XX.UL	10	420	200	400	375	160	101,7
ATF2.11000.XX.UL	11	420	210	400	375	170	106,1
ATF2.12000.XX.UL	12	420	220	400	375	180	116,3
ATF2.13000.XX.UL	13	420	230	400	375	190	125,4
ATF2.14000.XX.UL	14	420	230	400	375	190	131,2
ATF2.15000.XX.UL	15	420	240	400	375	200	139,8
ATF2.16000.XX.UL	16	480	220	450	425	184	145,5
ATF2.17000.XX.UL	17	480	230	450	425	194	158,3
ATF2.18000.XX.UL	18	480	240	450	425	204	172,5

AUTOTRASFORMATORI TRIFASE "UL RECOGNIZED" "UL RECOGNIZED" THREE-PHASE AUTOTRANSFORMER

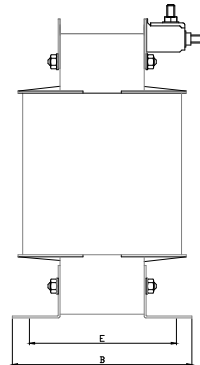
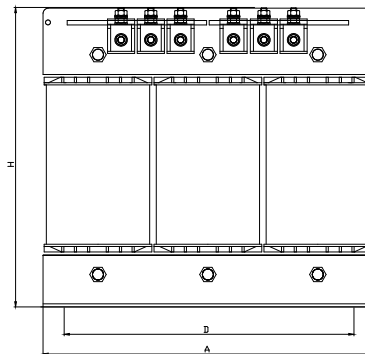

Autotrasformatore associato non resistente al cortocircuito
Autotrasformatore da incorporare in apparati elettrici specifici

Norme di riferimento: EN 61558-2-13, EN 60076-11, UL5085+CSA 22.2

Frequenza: 50/60 Hz

Classe termica e d'isolamento: F

Temperatura ambiente: 40 °C

Tensione di lavoro: 230/400 V

Centro stella con neutro accessibile

*Associated autotransformer non-short-circuit proof
Transformer for special electric equipment*

Reference standards: EN 61558-2-13, EN 60076-11, UL5085+CSA 22.2

Frequency: 50/60 Hz

Thermal & insulation class: F

Ambient temperature: 40 °C

Working voltage: 230/400 V

Available neutral conductor

CODICE PART NUMBER	POTENZA POWER [kVA]	Larghezza Width A [mm]	Profondità Depth B [mm]	Altezza Height H [mm]	Fissaggio Fixing D [mm]	Fissaggio Fixing E [mm]	Peso Weight [kg]
ATF3.01000.XX.UL	1	180	130	200	150	96	12,0
ATF3.01300.XX.UL	1,3	240	130	250	200	97	17,8
ATF3.01600.XX.UL	1,6	240	130	250	200	97	18,9
ATF3.02000.XX.UL	2	240	140	250	200	112	23,1
ATF3.02200.XX.UL	2,2	300	150	300	250	112	28,8
ATF3.02500.XX.UL	2,5	300	150	300	250	122	28,8
ATF3.02800.XX.UL	2,8	300	150	300	250	132	30,4
ATF3.03000.XX.UL	3	300	160	300	250	142	35,6
ATF3.03200.XX.UL	3,2	300	160	300	250	142	36,1
ATF3.03500.XX.UL	3,5	300	160	300	250	142	37,1
ATF3.04000.XX.UL	4	300	160	300	250	152	38,1
ATF3.04500.XX.UL	4,5	300	170	300	250	162	43,3
ATF3.05000.XX.UL	5	360	170	350	325	135	48,6
ATF3.05500.XX.UL	5,5	360	170	350	325	145	48,6
ATF3.06000.XX.UL	6	360	180	350	325	155	66,4
ATF3.06300.XX.UL	6,3	420	180	400	375	140	84,2
ATF3.07000.XX.UL	7	420	190	400	375	150	87,8
ATF3.08000.XX.UL	8	420	180	400	375	160	84,2
ATF3.09000.XX.UL	9	420	190	400	375	170	87,8
ATF3.10000.XX.UL	10	420	200	400	375	180	101,7
ATF3.11000.XX.UL	11	420	210	400	375	190	106,1
ATF3.12000.XX.UL	12	420	220	400	375	200	116,3
ATF3.13000.XX.UL	13	480	220	450	425	164	145,5
ATF3.14000.XX.UL	14	480	220	450	425	164	145,5
ATF3.15000.XX.UL	15	480	230	450	425	174	145,5
ATF3.16000.XX.UL	16	480	240	450	425	184	145,5
ATF3.17000.XX.UL	17	480	250	450	425	194	158,3
ATF3.18000.XX.UL	18	480	260	450	425	204	172,5

AUTOTRASFORMATORI TRIFASE "UL RECOGNIZED" "UL RECOGNIZED" THREE-PHASE AUTOTRANSFORMER

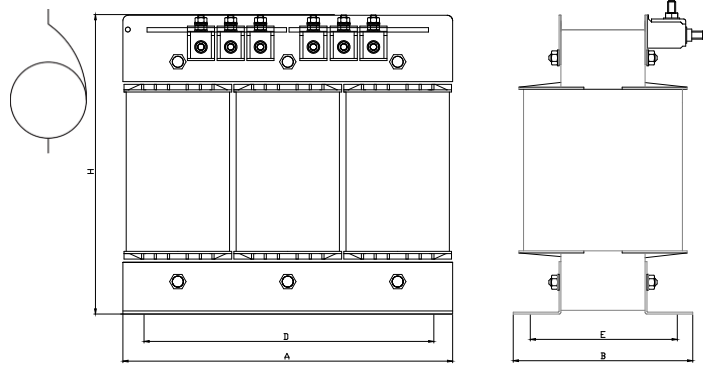

Autotrasformatore reversibile associato non resistente al cortocircuito
Autotrasformatore da incorporare in apparati elettrici specifici

Norme di riferimento: EN 61558-2-13, EN 60076-11, UL5085+CSA 22.2
Frequenza: 50/60 Hz
Classe termica e d'isolamento: H
Temperatura ambiente: 40 °C
Tensione di lavoro: 230/400 V
Centro stella con neutro accessibile

*Associated reversible autotransformer non-short-circuit proof
Transformer for special electric equipment*

*Reference standards: EN 61558-2-13, EN 60076-11, UL5085+CSA 22.2
Frequency: 50/60 Hz
Thermal & insulation class: H
Ambient temperature: 40 °C
Working voltage: 230/400 V
Available neutral conductor*

CODICE PART NUMBER	POTENZA DI NUCLEO CORE POWER [kVA]	Larghezza Width A [mm]	Profondità Depth B [mm]	Altezza Height H [mm]	Fissaggio Fixing D [mm]	Fissaggio Fixing E [mm]	Peso Weight [kg]
ATH3.020000.XX.UL	20	480	340	480	425	204	140
ATH3.023000.XX.UL	23	480	350	480	425	214	155
ATH3.025000.XX.UL	25	480	360	480	425	224	165
ATH3.030000.XX.UL	30	480	370	480	425	234	174
ATH3.035000.XX.UL	35	600	375	600	550	190	185
ATH3.040000.XX.UL	40	600	385	600	550	200	200
ATH3.045000.XX.UL	45	600	395	600	550	210	220
ATH3.050000.XX.UL	50	600	405	600	550	220	240
ATH3.063000.XX.UL	63	600	425	600	550	240	270
ATH3.070000.XX.UL	70	600	445	600	550	260	310
ATH3.080000.XX.UL	80	600	475	600	550	270	360
ATH3.090000.XX.UL	90	600	475	600	550	270	360
ATH3.100000.XX.UL	100	680	560	680	470	320	420

AUTOTRASFORMATORI TRIFASE "UL LISTED" "UL LISTED" THREE-PHASE AUTOTRANSFORMERS

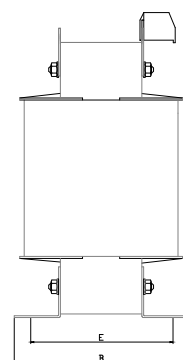
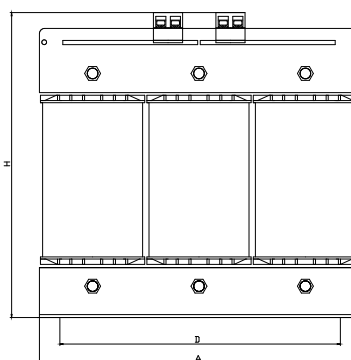

Autotrasformatore associato non resistente al cortocircuito
Autotrasformatore da incorporare in sistemi elettrici speciali

Norme di riferimento: EN 61558-2-13, UL5085+CSA 22.2

Frequenza: 50/60 Hz

Classe termica e d'isolamento: F

Temperatura ambiente: 40 °C

Tensione di lavoro: 230/400 V

Centro stella con neutro accessibile

*Associated autotransformer non-short-circuit proof
Transformer for special electric equipment*

Reference standards: EN 61558-2-13, UL5085+CSA 22.2

Frequency: 50/60 Hz

Thermal & insulation class: F

Ambient temperature: 40 °C

Working voltage: 230/400 V

Available neutral terminal

CODICE PART NUMBER	POTENZA DI NUCLEO CORE POWER [kVA]	Larghezza Width A [mm]	Profondità Depth B [mm]	Altezza Height H [mm]	Fissaggio Fixing D [mm]	Fissaggio Fixing E [mm]	Peso Weight [kg]
ATF2.00500.XX.UL	0,5	180	115	200	150	81	9,1
ATF2.00630.XX.UL	0,63	180	120	200	150	86	9,6
ATF2.00800.XX.UL	0,8	180	120	200	150	86	10,2
ATF2.01000.XX.UL	1	180	130	200	150	96	12,0
ATF2.01300.XX.UL	1,3	240	130	250	200	87	17,8
ATF2.01600.XX.UL	1,6	240	130	250	200	87	18,9
ATF2.02000.XX.UL	2	240	140	250	200	97	23,1
ATF2.02200.XX.UL	2,2	240	140	250	200	97	23,6
ATF2.02500.XX.UL	2,5	300	150	300	250	112	28,8
ATF2.02800.XX.UL	2,8	300	150	300	250	112	30,4
ATF2.03000.XX.UL	3	300	160	300	250	122	35,6
ATF2.03200.XX.UL	3,2	300	160	300	250	122	36,1
ATF2.03500.XX.UL	3,5	300	160	300	250	122	37,1
ATF2.04000.XX.UL	4	300	160	300	250	122	38,1

AUTOTRASFORMATORI TRIFASE “UL LISTED” “UL LISTED” THREE-PHASE AUTOTRANSFORMER

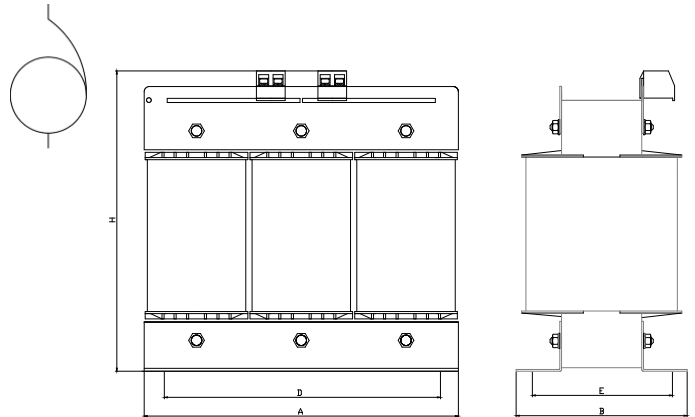

Autotrasformatore associato non resistente al cortocircuito
Autotrasformatore da incorporare in apparati elettrici specifici

*Associated autotransformer non-short-circuit proof
Transformer for special electric equipment*

87

Norme di riferimento: EN 61558-2-13, UL 5085+CSA 22.2
Frequenza: 50/60 Hz
Classe termica e d'isolamento: F
Temperatura ambiente: 40 °C
Tensione di lavoro: 230/400 V
Centro stella con neutro accessibile

*Reference standards: EN 61558-2-13, UL 5085+CSA 22.2
Frequency: 50/60 Hz
Thermal & insulation class: F
Ambient temperature: 40 °C
Working voltage: 230/400 V
Available neutral terminal*

CODICE PART NUMBER	POTENZA POWER [kVA]	Larghezza Width A [mm]	Profondità Depth B [mm]	Altezza Height H [mm]	Fissaggio Fixing D [mm]	Fissaggio Fixing E [mm]	Peso Weight [kg]
ATF3.01000.XX.UL	1	180	130	200	150	96	12,0
ATF3.01300.XX.UL	1,3	240	130	250	200	97	17,8
ATF3.01600.XX.UL	1,6	240	130	250	200	97	18,9
ATF3.02000.XX.UL	2	240	140	250	200	112	23,1
ATF3.02200.XX.UL	2,2	300	150	300	250	112	28,8
ATF3.02500.XX.UL	2,5	300	150	300	250	122	28,8
ATF3.02800.XX.UL	2,8	300	150	300	250	132	30,4
ATF3.03000.XX.UL	3	300	160	300	250	142	35,6
ATF3.03200.XX.UL	3,2	300	160	300	250	142	36,1
ATF3.03500.XX.UL	3,5	300	160	300	250	142	37,1
ATF3.04000.XX.UL	4	300	160	300	250	152	38,1

REATTANZE

REACTORS

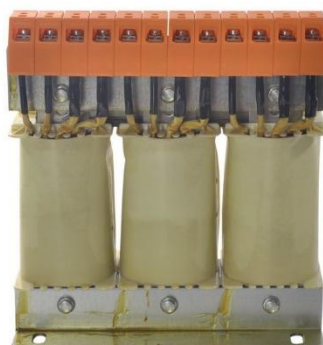
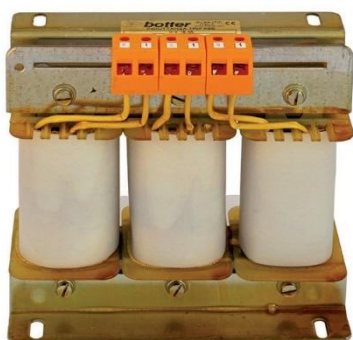

CARATTERISTICHE GENERALI

GENERAL FEATURES

- Apparecchiatura non protetta contro i contatti diretti ed indiretti, destinata ad essere incorporata in incogniti equipaggiamenti elettrici;
- Apparecchiatura non resistente ai cortocircuiti ed ai sovraccarichi;
- Grado di protezione contro i contatti diretti IP00 secondo le norme EN 60529;
- Apparecchiatura destinata ad una installazione fissa;
- Temperatura ambiente: -25 °C / +40 °C;
- Classe di sovratemperatura: B/F/H;
- Classe di isolamento: B/F/H;
- Costruzione secondo le norme EN 61558 e EN 60076-6
- Nucleo magnetico in lamierino al silicio a bassa cifra di perdita;
- Apparecchiatura tropicalizzata con vernici essiccanti in aria o a forno in classe H;
- Avvolgimenti in filo di rame o alluminio smaltato con resine in classe H (180 °C);
- Varie posizioni di montaggio permesse dalla particolare conformazione del supporto metallico;
- Materiale e componenti usati per la realizzazione della reattanza sono certificati e conformi alle relative norme;
- **TUTTE LE REATTANZE POSSONO ESSERE COSTRUITE CON SISTEMA DI ISOLAMENTO OMOLOGATO UL SECONDO LA NORMA UL 1446 "Systems of insulating materials".**
- *Devices not protected against direct and indirect contacts, intended to be incorporated in unknown electric equipment;*
- *Devices non-short-circuit and overload proof;*
- *IP00 protection degree against direct contacts according to EN 60529 standard;*
- *Devices intended for fix installation;*
- *Ambient temperature: -25 °C / +40 °C;*
- *Temperature class: B/F/H;*
- *Insulation class: B/F/H;*
- *EN 61558 and EN 60076-6 manufacturing standards;*
- *Lamination core manufactured using silicon steel sheets characterized by low power losses;*
- *Devices tropicalized by using H class varnish; drying process by natural air or by oven;*
- *H class (180 °C) magnetic copper or aluminium wire windings;*
- *Intended for different assembling layouts due to a big number of available metallic brakes;*
- *Materials and components used for reactors manufacturing are certified and conforming to their standards;*
- **ALL REACTORS MAY BE MANUFACTURED WITH UL HOMOLOGATED INSULATION SYSTEM ACCORDING TO UL 1446 STANDARD "Systems of insulating materials".**

NOTE GENERALI SULLE REATTANZE PER AVVIAMENTO MOTORE GENERAL NOTES ABOUT ON MOTOR STARTING REACTORS

Seguire i punti da 1 a 9 e il punto 15 di pagina 16 sostituendo la parola "reattanza" alla parola "trasformatore".

- 1) La reattanza è dimensionata per poter avviare il motore a cui è collegata e non per funzionare continuamente in serie allo stesso;
- 2) La reattanza è dimensionata per poter effettuare da 4 a 5 avviamenti all'ora, con tempi di circa 20/25 secondi per avviamento;
- 3) La reattanza è progettata per poter funzionare ad una frequenza nominale di 50 Hz;
- 4) Per avviamenti "leggeri", nei quali le correnti di spunto intervengono per tempi relativamente brevi a seguito della partenza del motore (pompe non in pressione, ecc.), non sono necessarie reattanze a gradini intermedi. Reattanze a gradini di avviamento intermedi diventano necessarie quando il motore da avviare è sottoposto a spunti con tempi più lunghi (macchine con volani, pompe in pressione, ecc.);
- 5) Le reattanze senza gradini intermedi sono normalmente dimensionate per provocare una caduta di tensione del 30/35% rispetto alla tensione nominale al momento della partenza del motore;
- 6) Le cadute di tensione per le reattanze a gradini vengono determinate di volta in volta in base alla specifica richiesta;
- 7) La caduta di tensione, determinata dalle reattanze, riduce proporzionalmente la corrente allo spunto e la coppia all'albero motore.

Follow steps from 1 to 9 and step 15 of page 16 replacing the word "transformer" with the word "reactor".

- 1) The reactor is designed to start the motor to which it is connected, and not to operate continuously in series with it;
- 2) The reactor is designed to perform from 4 to 5 start-up/hour of about 20/25 seconds each;
- 3) The reactor has been designed to operate at a 50 Hz rated frequency;
- 4) For "light" start-up in which the motors inrush currents last for short periods (pump not pressurised, etc.) reactors with intermediate steps are not required; these are necessary when the motor to be started is subjected to inrush currents with longer times (machines with fly-wheels, pressurised pump, etc.);
- 5) Reactors without intermediate steps are normally dimensioned to cause a voltage drop of 30/35% the rated voltage value at motor start-up;
- 6) Voltage drops for reactors with several steps are determined each time on the basis of the specific requests;
- 7) The voltage drop caused by reactors, reduces the inrush current and torque at the motor shaft.

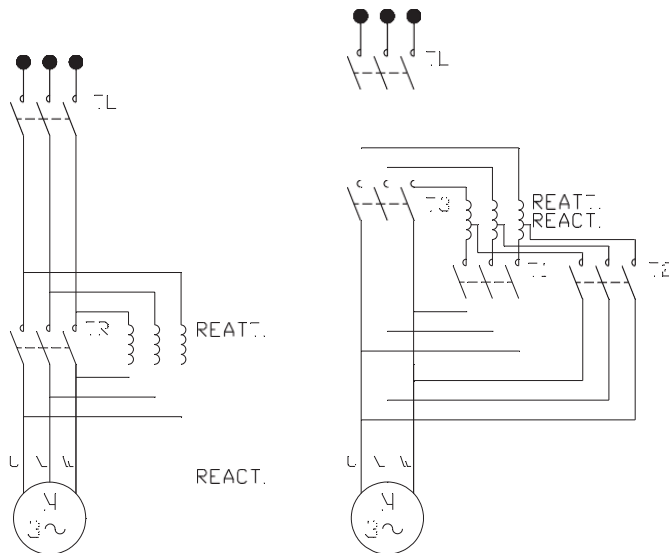

FIG. N° 1

FIG. N° 2

Fig. n°1

Avviamento a tensione ridotta di un motore tramite reattanza senza gradini

Il teleruttore TR (temporizzato) deve intervenire per escludere la reattanza una volta che il motore è avviato

Start-up at a reduced voltage of a motor with no step reactor

The timed TR switch cuts off the reactor once the motor is started.

Fig. n°2

Avviamento a tensione ridotte di un motore tramite reattanza a gradini

All'avviamento si chiudono i contattori TL e T1 (caduta di tensione massima), dopo un primo intervallo di tempo si chiude T2 (caduta di tensione minima) e dopo un secondo intervallo si chiude T3 e si aprono T1 e T2 (alimentazione a piena tensione)

Start-up at a reduced voltage of a motor with stepped reactor

At start-up the contactors TL and T1 are closed (maximum voltage drop), after a first time lapse T2 closes (minimum voltage drop) and after a second time lapse T3 closes and T1 and T2 open (full voltage power supply).

REATTANZE PER AVVIAMENTO MOTORI ASINCRONI TRIFASE STARTING REACTORS FOR ASYNCHRONOUS THREE-PHASE MOTORS

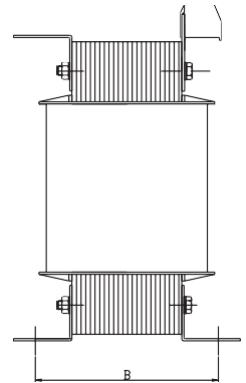
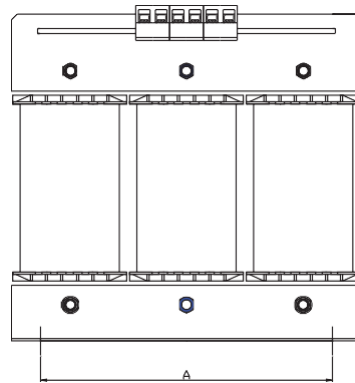
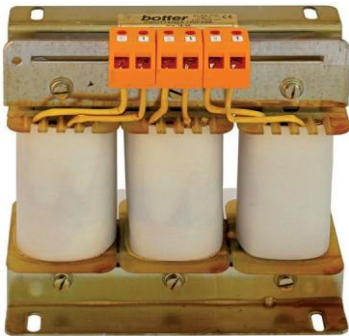

Reattanza adatta per motori avviati a vuoto o sotto carico. Tutti i tipi di reattanza possono essere prodotti per avviamenti leggeri, a un gradino, oppure a due o tre gradini per avviamenti più gravosi.

Norme di riferimento: EN 61558-2-20, EN 60076-6

Frequenza: 50/60 Hz

Classe termica e d'isolamento: F

Temperatura ambiente: 40 °C

Tensione di lavoro: 400 V (a richiesta 230 V)

Caduta di tensione: 35% della tensione nominale del motore

Numero avviamenti/ora: 4/5

Durata dell'avviamento: 20/25 secondi

Opzione: protettore termico ripristinabile

Reactor suitable for load or no-load motors starting. All reactors may be manufactured for light starting, typical of one step motor starting, or with two or three steps, for heavy starting.

Reference standards: EN 61558-2-20, EN 60076-6

Frequency: 50/60 Hz

Thermal & insulation class: F

Ambient temperature: 40 °C

Working voltage: 400 V (230 V available)

Voltage drop at start up: 35% of motor rated voltage

Number of start-up/hour: 4/5

Start-up time: 20/25 seconds

Option: restorable thermal protector

CODICE PART NUMBER	POTENZA POWER [Hp]	Larghezza Width [mm]	Profondità Depth [mm]	Altezza Height [mm]	Fissaggio Fixing A [mm]	Fissaggio Fixing B [mm]	Peso Weight [kg]
BTRT357	7,5	150	105	175	125	69	5,1
BTRT358	10	150	105	175	125	69	5,5
BTRT359	15	150	105	175	125	69	5,7
BTRT360	20	180	110	200	150	76	7,7
BTRT361	25	180	110	200	150	76	7,9
BTRT362	30	180	110	200	150	76	8,2
BTRT363	40	240	120	250	200	77	13,7
BTRT364	50	240	130	250	200	87	16,6
BTRT365	60	240	140	250	200	97	19,6
BTRT366	70	300	140	300	250	102	24,7
BTRT367	100	300	150	300	250	112	29,6
BTRT368	150	360	160	350	325	125	43,0
BTRT369	200	360	170	350	325	135	53,6
BTRT370	300	360	180	350	325	145	61,4

NOTE GENERALI SULLE REATTANZE DI FILTRO

GENERAL REMARKS ON FILTERING REACTORS

- Dispositivo usato in ingresso o uscita ad azionamenti elettrici per la protezione dai disturbi elettromagnetici dei componenti ad esso collegati;
- Reattanza “di ingresso”: reattanza interposta tra l'alimentazione e l'azionamento con lo scopo di proteggerlo e limitare i disturbi elettromagnetici da esso generato;
- Reattanza “di uscita”: reattanza interposta tra l'azionamento e il motore elettrico da esso pilotato, con lo scopo di attenuare le armoniche e di proteggerlo;
- Nucleo magnetico in lamierino al silicio a bassissima cifra di perdita per evitarne la saturazione;
- Avvolgimenti in filo di rame o alluminio smaltato con resine in classe H (180 °C);
- Dispositivo non protetto contro i contatti diretti ed indiretti, destinato ad essere incorporato in incogniti equipaggiamenti elettrici;
- Dispositivo non resistente ai cortocircuiti ed ai sovraccarichi;
- Grado di protezione IP00 contro i contatti diretti secondo le norme EN 60529;
- Apparecchiatura destinata ad installazione fissa;
- Temperatura ambiente: +25°C / +40 °C;
- Classe di sovratemperatura: B/F/H;
- Classe di isolamento: B/F/H;
- Costruzione secondo le norme EN 61558-2-20 e EN 60076-6
- Apparecchiatura tropicalizzata con vernici essiccanti in aria o a forno in classe H;
- Varie posizioni di montaggio permesse dalla particolare conformazione del supporto metallico;
- Materiale e componenti usati per la realizzazione della reattanza sono certificati e conformi alle relative norme;
- **TUTTE LE REATTANZE POSSONO ESSERE COSTRUITE CON SISTEMA DI ISOLAMENTO OMOLOGATO UL SECONDO LA NORMA UL 1446 “Systems of insulating materials”.**
- *Devices to be used in input or output position of electric drives for protection against electromagnetic disturbances which may affect components connected to them;*
- *Input reactor: device interposed between power supply and drive, with the purpose of protecting it and limiting electromagnetic disturbances;*
- *Output reactor: device interposed between drive and motor with the purpose of harmonics limiting and motor protection;*
- *Lamination core manufactured using silicon steel sheets characterized by very low power losses in order to avoid core saturation;*
- *H class (180 °C) magnetic copper or aluminium wire windings;*
- *Device not protected against direct and indirect contacts, intended to be incorporated in unknown electric equipment;*
- *Devices non-short-circuit proof;*
- *IP00 protection degree against direct contacts according to EN 60529 standard;*
- *Devices intended for fix installation;*
- *Ambient temperature: +25°C / +40 °C;*
- *Temperature class: B/F/H;*
- *Insulation class: B/F/H;*
- *EN 61558-2-20 and EN 60076-6 manufacturing standards;*
- *Devices tropicalized by using H class varnish; drying process by natural air or by oven;*
- *Intended for different assembling layouts due to a big number of available metallic supports;*
- *Materials and components used for reactors manufacturing are certified and conforming to their standards;*
- **ALL REACTORS MAY BE MANUFACTURED WITH UL HOMOLOGATED INSULATION SYSTEM ACCORDING TO UL 1446 STANDARD “Systems of insulating materials”.**

INDUTTANZE TRIFASE DI FILTRO “IN USCITA” THREE-PHASE OUTPUT FILTERING REACTORS

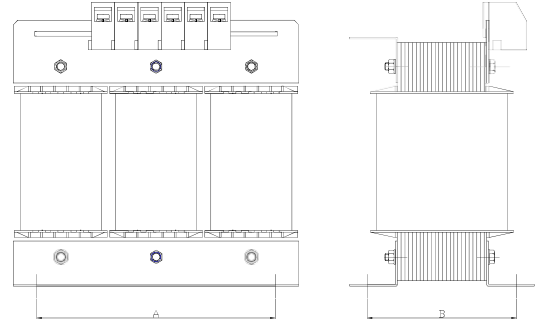

Induttanza da inserire a valle dell'azionamento o di altri sistemi di conversione con lo scopo di ridurre il carico armonico in essi generato, con i seguenti vantaggi:

- Riduzione del carico armonico al motore;
- Riduzione dei disturbi elettromagnetici;
- Riduzione della temperatura di funzionamento del motore;

Protezione dell'isolamento elettrico del motore e allungamento della vita utile.

Norme di riferimento: EN 61558-2-20, EN 60076-6

Frequenza nominale del motore: 50/60 Hz

Classe termica e d'isolamento: F

Temperatura ambiente: 40 °C

Tensione di lavoro: 400 V / 690 V

Frequenza di switching: da 2 a 16 kHz

Possono essere fornite anche in esecuzione monofase e/o con protettore termico ripristinabile

Reactor to be inserted after electric drive or after other conversion systems with the purpose of harmonics reduction and with other following benefits:

- Harmonic load reduction at motor;
- Electromagnetic noises reduction;
- Motor working temperature reduction;

Motor insulation protection and significant increase of service life.

Reference standards: EN 61558-2-20, EN 60076-6

Motor rated frequency: 50/60 Hz

Thermal & insulation class: F

Ambient temperature: 40 °C

Grid voltage: 400 V / 690 V

Switching frequency: 2 to 16 kHz

Available in single-phase execution and/or with restorable thermal protector

CODICE PART NUMBER	POTENZA MOTORE MOTOR POWER [kW]	INDUTTANZA Inductance [mH]	CORRENTE Current [A]	Larghezza Width [mm]	Profondità Depth [mm]	Altezza Height [mm]	Fissaggio Fixing A [mm]	Fissaggio Fixing B [mm]	Peso Weight [kg]
BTIT400OUT	1,5	1,5	4	120	100	150	100	60	2,0
BTIT401OUT	3	0,8	8	120	100	150	100	60	2,4
BTIT402OUT	4	0,6	10	120	100	150	100	60	2,6
BTIT403OUT	6	0,45	15	120	100	150	100	60	2,8
BTIT404OUT	8	0,35	17	120	100	150	100	60	2,9
BTIT405OUT	11	0,25	25	120	100	150	100	60	3,1
BTIT406OUT	15	0,19	32	150	100	180	125	56	3,3
BTIT407OUT	22	0,13	45	150	100	180	125	56	3,6
BTIT408OUT	30	0,10	60	150	100	180	125	56	4
BTIT409OUT	37	0,085	73	150	140	180	125	70	5,5
BTIT410OUT	45	0,065	90	150	140	180	125	70	5,9
BTIT411OUT	55	0,05	120	180	120	200	150	72	6,9
BTIT412OUT	75	0,04	160	180	120	200	150	72	7,9
BTIT413OUT	90	0,033	180	180	120	200	150	82	11
BTIT414OUT	132	0,025	230	180	120	200	150	92	13

INDUTTANZE TRIFASE DI FILTRO “IN INGRESSO” THREE-PHASE INPUT FILTERING REACTORS

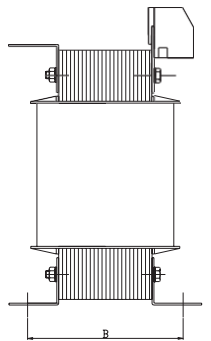
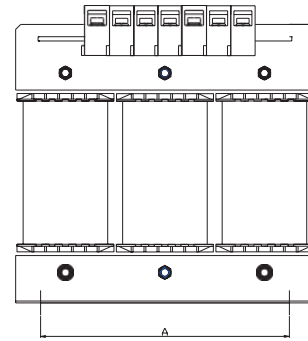

Induttanza da inserire a monte dell’azionamento o di altri sistemi di conversione con lo scopo di proteggerli da picchi di corrente e armoniche, con i seguenti vantaggi:

- protezione dalla presenza di armoniche presenti nella rete di alimentazione;
- protezione da sovracorrenti dovute a transitori di inserzione;
- riduzione di eventuali disturbi che possono essere immessi nella rete di alimentazione.

Reactor to be inserted before electric drive or before other conversion systems with the purpose of protecting them from harmonics and current spikes, and with other following benefits:

- protection from harmonics which may affect power supply line;
- protection from inrush currents due to insertion transients;
- reduction of noises that may be introduced in power supply network.

94

Norme di riferimento: EN 61558-2-20, EN 60076-6
 Frequenza nominale del motore: 50/60 Hz
 Classe termica e d’isolamento: F
 Temperatura ambiente: 40 °C
Tensione di lavoro: 400 V / 690 V

Reference standards: EN 61558-2-20, EN 60076-6
 Motor rated frequency: 50/60 Hz
 Thermal & insulation class: F
 Ambient temperature: 40 °C
Working voltage: 400 V / 690 V

Possono essere fornite anche in esecuzione monofase e/o con protettore termico ripristinabile

Available in single-phase execution and/or with restorable thermal protector

CODICE PART NUMBER	POTENZA INVERTER DRIVE RATED POWER [kW]	INDUTTANZA Inductance [mH]	CORRENTE Current [A]	Larghezza Width [mm]	Profondità Depth [mm]	Altezza Height [mm]	Fissaggio Fixing A [mm]	Fissaggio Fixing B [mm]	Peso Weight [kg]
BTIT400IN	1,5	7,2	4	120	100	150	100	60	2,5
BTIT401IN	3	4,2	7	120	100	150	100	60	2,9
BTIT402IN	4	2,5	11	150	100	175	125	54	3,8
BTIT403IN	8	1,9	16	150	120	175	125	70	5,8
BTIT404IN	10	1,5	21	180	120	200	150	76	6,8
BTIT405IN	15	1	30	180	130	200	150	86	8,3
BTIT406IN	18	0,85	35	180	140	200	150	96	9,8
BTIT407IN	21	0,65	46	240	130	250	200	78	12,0
BTIT408IN	30	0,50	60	240	140	250	200	88	14,7
BTIT409IN	37	0,40	75	240	150	250	200	98	17,5
BTIT410IN	45	0,30	95	240	165	250	200	112	21,5
BTIT411IN	55	0,23	124	300	150	300	250	102	23,8
BTIT412IN	75	0,20	156	300	160	300	250	112	28,0
BTIT413IN	90	0,15	180	300	160	300	250	112	29,5
BTIT414IN	100	0,13	230	300	180	300	250	132	36,4
BTIT415IN	160	0,10	280	240	200	300	160	150	40,0
BTIT416IN	200	0,075	400	300	200	360	200	160	52,0
BTIT417IN	250	0,060	500	350	190	390	230	150	65,0

ALIMENTATORI

POWER SUPPLIES

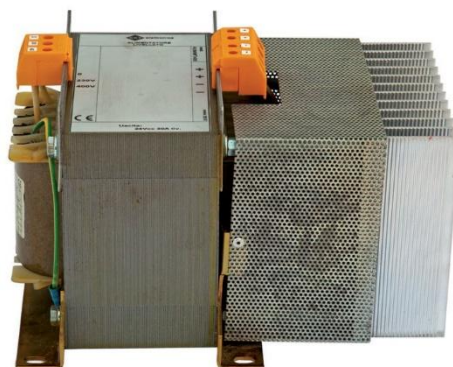
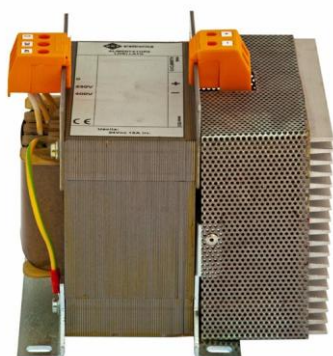

CARATTERISTICHE GENERALI

GENERAL FEATURES

- Alimentatore non protetto contro i contatti diretti ed indiretti, destinato all'alimentazione di dispositivi in corrente continua;
- Alimentatore non protetto contro il cortocircuito;
- Grado di protezione contro i contatti diretti IP00 secondo le norme EN 60529;
- Temperatura ambiente: -25 °C / +40 °C;
- Classe di sovratemperatura: B/F;
- Classe di isolamento: B/F;
- Costruzione secondo la norma EN 61558;
- Nucleo magnetico in lamierino al silicio a bassa cifra di perdita;
- Trasformatore tropicalizzato con vernici essiccanti in aria o a forno in classe H;
- Avvolgimenti in filo di rame o alluminio smaltato con resine in classe H (180 °C);
- Materiale e componenti usati per la realizzazione del trasformatore sono certificati e conformi alle relative norme.
- *Power supply unit not protected against direct and indirect contacts, intended to supply direct current systems;*
- *Power supply unit non-short-circuit proof;*
- *IP00 protection degree against direct contacts according to EN 60529 standard;*
- *Ambient temperature: -25 °C / +40 °C;*
- *Temperature class: B/F;*
- *Insulation class: B/F;*
- *EN 61558 manufacturing standards;*
- *Lamination core manufactured using silicon steel sheets characterized by low power losses;*
- *Transformers tropicalized by using H class varnish; drying process by natural air or by oven;*
- *H class (180 °C) magnetic copper or aluminium wire windings;*
- *Materials and components used for transformers manufacturing, are certified and conforming to their standards.*

NOTE

NOTES

A seconda della serie scelta si hanno differenti caratteristiche e qualità di segnale in uscita.

La serie BTALCM (compatta), è composta da trasformatore, gruppo raddrizzatore a diodi montato su appositi dissipatori e gruppo di livellamento.

Le serie BTALEC e BTALTF montano in aggiunta schermo elettrostatico e gruppo filtro R/C.

Nella serie BTALST, assieme ai componenti già citati viene montato sul dissipatore, oltre al gruppo raddrizzatore, anche un modulo stabilizzatore *switching* ad alta efficienza con protezione a limitazione di corrente.

Different signal characteristics are available according to the chosen Power Supply Units model.

BTALCM models (compact) are made up by transformer, diodes rectifier group assembled on specific heat-sinks, and leveling group.

BTALEC and BTALTF series are provided with electrostatic screen.

BTALST products are provided with both switching module and current-limiting protection.

ALIMENTATORI MONOFASE AC/DC LIVELLATI COMPATTI AC/DC LEVELLED COMPACT SINGLE-PHASE POWER SUPPLY UNITS

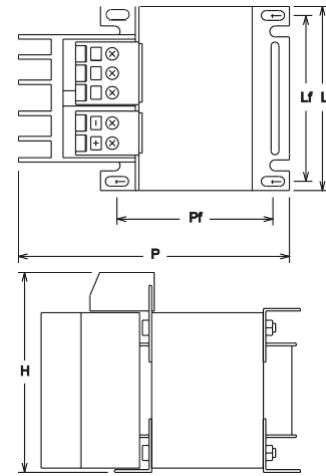

Alimentatore da incorporare in apparati elettrici specifici

Power supply unit for special electric equipment

Norme di riferimento: EN 61558-2-6

Reference standards: EN 61558-2-6

Frequenza: 50/60 Hz

Frequency: 50/60Hz

Classe termica e d'isolamento: F

Thermal & insulation class: F

Temperatura ambiente: 40 °C

Ambient temperature: 40 °C

Tensione primaria: 0/230/400 V

Primary voltage: 0/230/400 V

Tensione secondaria: 24 V DC livellata

Secondary voltage: 24 V DC levelled

Servizio intermittente

Intermittent duty cycle

CODICE PART NUMBER	Corrente di uscita Output current [A]	$\mu\text{F} \times \text{A}$	Vuoto/Carico No-load/Load [V]	Ripple Ripple [V]	L [mm]	P [mm]	H [mm]	Lf [mm]	Pf [mm]
BTALCM2402	2	500	± 3	$\pm 2,5$	75	80	87	55	50
BTALCM2404	4	550	± 3	± 5	85	115	97	75	65
BTALCM2406	6	550	± 3	± 5	96	115	115	85	60
BTALCM2408	8	580	± 3	± 5	96	125	115	85	70

COLLEGAMENTI ELETTRICI ELECTRICAL CONNECTIONS

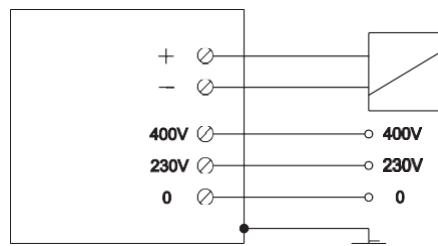

**CARICO
LOAD**

ALIMENTATORI MONOFASE AC/DC LIVELLATI AC/DC LEVELLED SINGLE-PHASE POWER SUPPLY UNITS

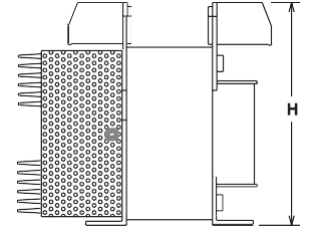
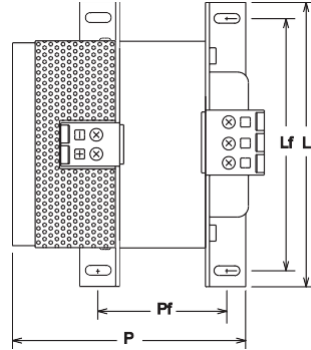
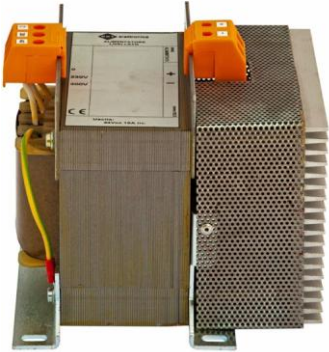

Alimentatore da incorporare in apparati elettrici specifici

Power supply unit for special electric equipment

Norme di riferimento: EN 61558-2-6

Frequenza: 50/60 Hz

Tensione primaria: 0/230/400 V

Tensione secondaria: 24V DC livellata

Servizio continuo a pieno carico nominale

Schermo elettrostatico

Reference standards: EN 61558-2-6

Frequency: 50/60 Hz

Primary voltage: 0/230/400 V

Secondary voltage: 24V DC levelled

Continuous duty cycle at maximum rated load

Electrostatic screen

CODICE PART NUMBER	Corrente di uscita Output current [A]	$\mu\text{F} \times \text{A}$	Vuoto/Carico No-load/Load [V]	Ripple Ripple [V]	L [mm]	P [mm]	H [mm]	Lf [mm]	Pf [mm]
BTALEC2402	2	500	± 3	$\pm 2,5$	108	90	97	96	50
BTALEC2404	4	550	± 3	± 5	132	110	97	117	55
BTALEC2406	6	530	± 3	± 5	132	120	105	117	65
BTALEC2408	8	550	± 3	± 5	155	130	125	140	65
BTALEC2410	10	540	± 3	± 5	155	135	125	140	70
BTALEC2415	15	620	± 3	± 5	155	150	125	140	85
BTALEC2420	20	560	± 3	$\pm 4,5$	155	180	125	140	95
BTALEC2425	25	560	± 3	$\pm 4,5$	195	220	165	180	100
BTALEC2430	30	540	± 3	$\pm 4,5$	195	230	165	180	100

COLLEGAMENTI ELETTRICI – ELECTRICAL CONNECTIONS

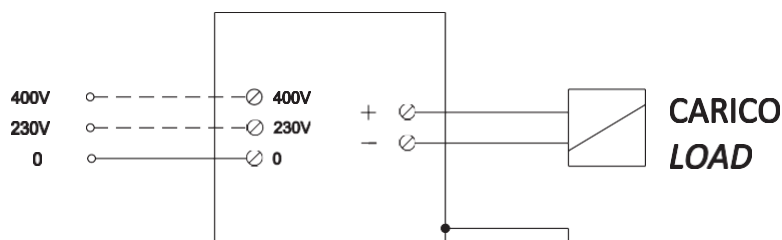

ALIMENTATORI MONOFASE AC/DC STABILIZZATI AC/DC STABILIZED SINGLE-PHASE POWER SUPPLY UNITS

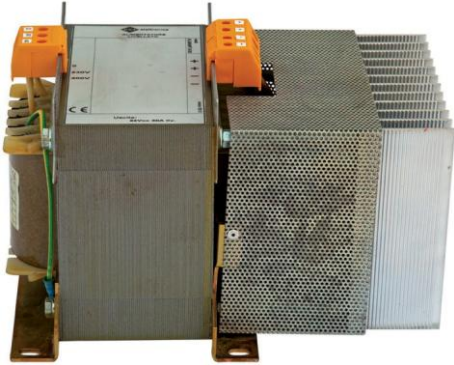

CE
UK
CA

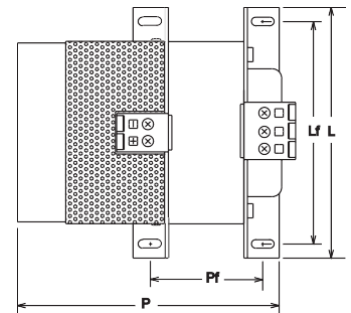
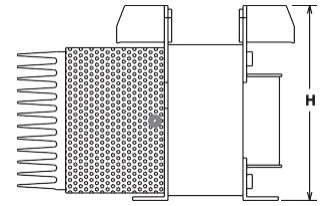
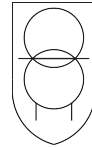

99

Alimentatore da incorporare in apparati elettrici specifici

Norme di riferimento: EN 61558-2-6

Frequenza: 50/60 Hz

Tensione primaria: 0/230/400 V

Tensione secondaria: 24 V DC livellata e stabilizzata

Servizio continuo a pieno carico nominale

Schermo elettrostatico

Power supply unit for special electric equipment

Reference standards: EN 61558-2-6

Frequency: 50/60Hz

Primary voltage: 0/230/400 V

Secondary voltage: 24 V DC levelled and stabilized

Continuous duty cycle at maximum rated load

Electrostatic screen

CODICE PART NUMBER	Corrente di uscita Output current [A]	ΔV (l nom) [%]	Vuoto/Carico No-load/Load [mV]	Ripple Ripple [mV]	L [mm]	P [mm]	H [mm]	Lf [mm]	Pf [mm]
BTALST24015	1,5	± 10	± 100	± 30	108	90	98	96	50
BTALST2403	3	± 10	± 100	± 30	132	110	105	117	55
BTALST2406	6	± 10	± 100	± 30	155	125	125	140	60
BTALST2409	9	± 10	± 100	± 30	155	175	125	140	75
BTALST2412	12	± 10	± 100	± 30	155	190	125	140	90

COLLEGAMENTI ELETTRICI – ELECTRICAL CONNECTIONS

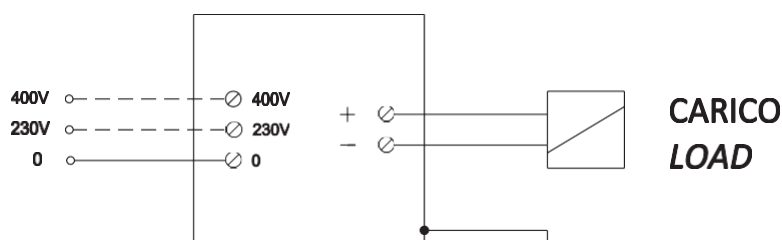

ALIMENTATORI TRIFASE AC/DC LIVELLATI AC/DC LEVELLED THREE-PHASE POWER SUPPLY UNITS

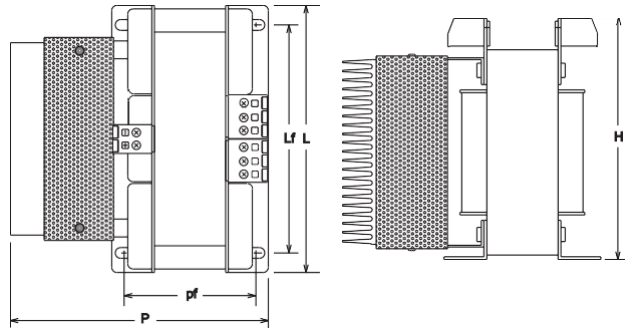

Alimentatore da incorporare in apparati elettrici specifici

Power supply unit for special electric equipment

Norme di riferimento: EN 61558-2-6

Reference standards: EN 61558-2-6

Frequenza: 50/60 Hz

Frequency: 50/60 Hz

Tensione primaria: 230/400 V trifase

Primary voltage: 230/400 V three-phase

Tensione secondaria: 24 V DC livellata monofase

Secondary voltage: 24 V DC levelled single-phase

Servizio continuo a pieno carico nominale

Continuous duty cycle at maximum rated load

Schermo elettrostatico

Electrostatic screen

CODICE PART NUMBER	Corrente di uscita Output current [A]	$\mu\text{F} \times \text{A}$	Vuoto/Carico No-load/Load [V]	Ripple Ripple [V]	L [mm]	P [mm]	H [mm]	Lf [mm]	Pf [mm]
BTALTF2408	8	550	± 2	$\pm 0,6$	140	120	140	125	55
BTALTF2415	15	630	± 2	$\pm 0,6$	140	135	140	125	70
BTALTF2425	25	560	± 2	$\pm 0,6$	180	175	160	150	80
BTALTF2435	35	520	$\pm 2,5$	$\pm 0,6$	180	185	160	150	90
BTALTF2450	50	560	$\pm 2,5$	$\pm 0,6$	240	230	225	200	90
BTALTF2470	70	520	$\pm 2,5$	$\pm 0,6$	240	245	225	200	100
BTALTF2480	80	520	$\pm 2,5$	$\pm 0,6$	240	260	225	200	115

COLLEGAMENTI ELETTRICI – ELECTRICAL CONNECTIONS

CON ALIMENTAZIONE 230V
WITH 230V SUPPLYING

CON ALIMENTAZIONE 400V
WITH 400V SUPPLYING

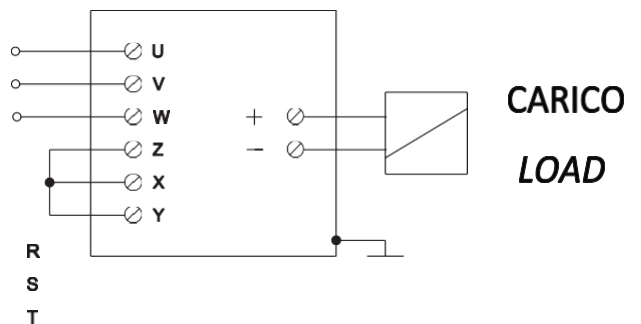
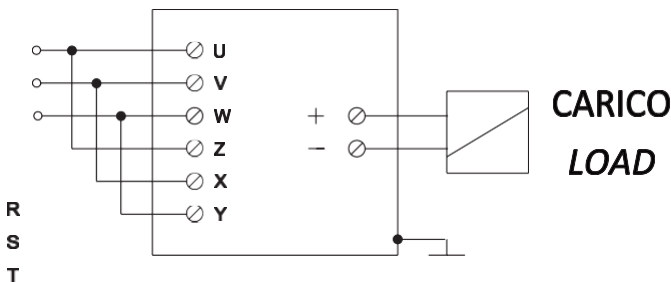

ACCESSORI

ACCESSORIES



101



BOX IP23 / IP44 / IP 54 / IP55 IP23 / IP44 / IP54 / IP55 BOXES

Materiale: lamiera verniciata
Colore: RAL 7035 (altri colori disponibili su richiesta)

Material: painted iron sheet
Color: RAL 7035 (other colors available)

CODICE PART NUMBER	Altezza Height H [mm]	Larghezza Width L [mm]	Profondità Depth P [mm]
BOX1.40IPxx	350	300	300
BOX2.50IPxx	400	350	350
BOX3.60IPxx	450	450	330
BOX5060IPxx	430	610	360
BOX7080IPxx	600	700	460
BOX90100IPxx	800	900	650
BOX1MCIPxx	1000	1000	1000
BOX1440IPxx	1200	1200	1000

BOX IP56 IP56 BOXES

Grado di protezione: IP56
Materiale: plastica
Colore: RAL 7035

Protection degree: IP56
Material: plastic
Color: RAL 7035

CODICE PART NUMBER	Dimensione Dimension a [mm]	Dimensione Dimension b [mm]	Dimensione Dimension c [mm]
BOXGW44217	190	140	140
BOXGW44218	240	190	160
BOXGW44219	300	220	180
BOXGW44220	380	300	180
BOXGW44221	460	380	180

BOX IP66 IP66 BOXES

Grado di protezione: IP66
Materiale: lamiera verniciata
Colore: RAL 7035 (altri colori disponibili su richiesta)
Disponibili anche con altre dimensioni

Protection degree: IP66
Material: painted iron sheet
Color: RAL 7035 (other colors available)
Other dimensions are also available

CODICE PART NUMBER	Dimensione Dimension a [mm]	Dimensione Dimension b [mm]	Dimensione Dimension c [mm]
BOXD93/1	300	200	150
BOXD93/9	400	400	200
BOXD93/15	500	400	250
BOXD93/20	600	600	250
BOXD93/27	800	600	300
BOXD93/30	900	600	300
BOXD93/35	1000	800	300

BOX IP23 / IP44 / IP 54 / IP55
IP23 / IP44 / IP54 / IP55 BOXES

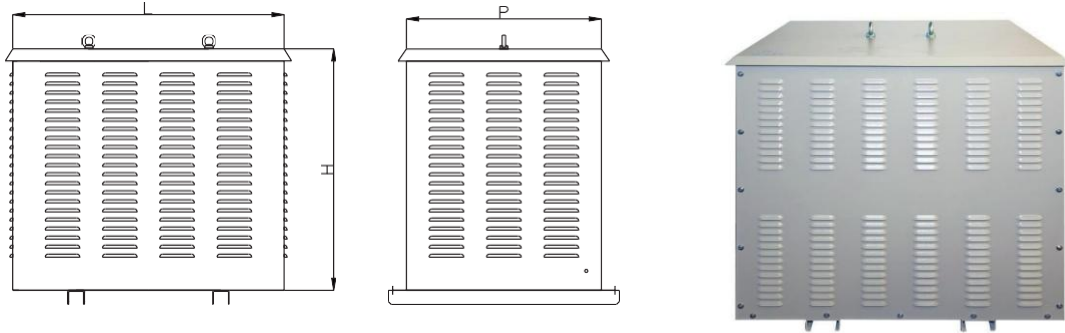

BOX IP56
IP56 BOXES

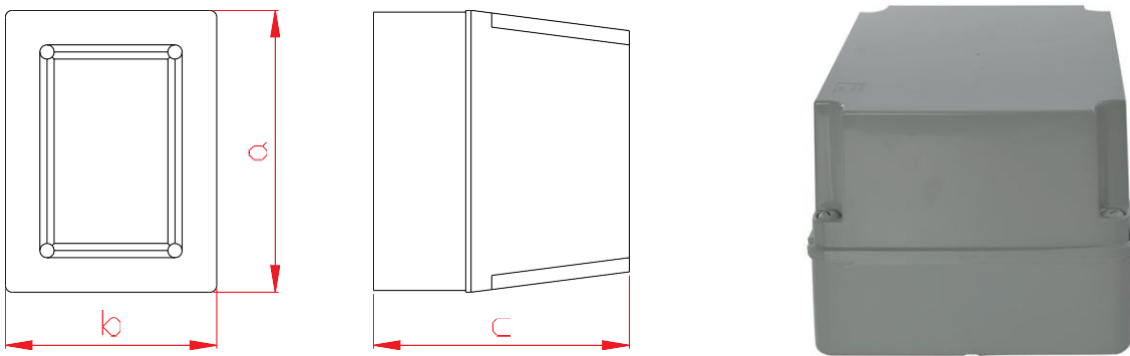

BOX IP66
IP66 BOXES

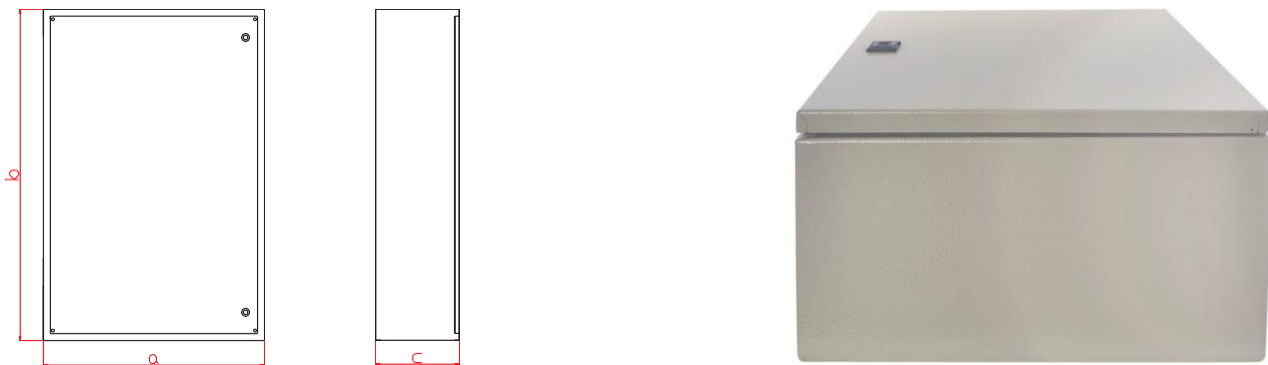

ACCESSORI VARI
OTHERS ACCESSORIES



Interruttore magnetotermico
Circuit breaker



Portafusibile di potenza
Power fuse holder



Gabbie IP20
IP20 cases



Raddrizzatori
Rectifiers



Protettori termici
Thermal protectors circuit breakers

ACCESSORI VARI
OTHERS ACCESSORIES



Box IP54 con filtri e ventole
IP54 box with filters and fans



Ruote di scorrimento
Sliding wheels

105



Centralina di controllo temperatura
Temperature monitoring unit



Supporti antivibranti
Anti-vibration supports

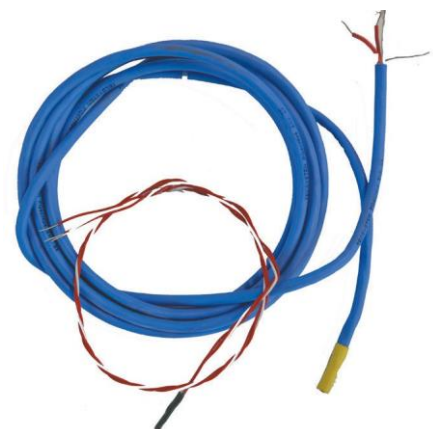

Sensori termici PT100
PT100 temperature probes

ESECUZIONI SPECIALI SPECIAL REQUESTS



Autotrasformatori trifase
con morsetti per guida DIN
*DIN rail terminals
three-phase autotransformers*



Trasformatori in box
con prese e spine CEE
*Cased transformers with CEE
plugs and sockets*



Trasformatori toroidali resinati
Cast-resin toroidal transformers



Trasformatori toroidali IP68
IP68 toroidal transformers



Trasformatori con connettori molex
Transformers with molex connectors

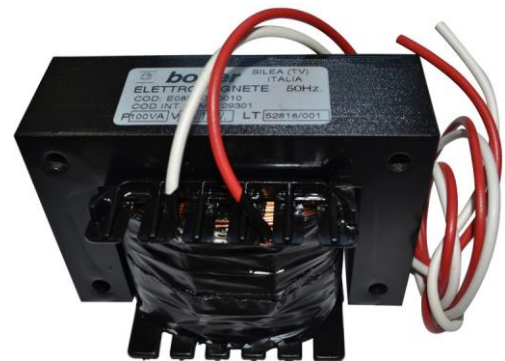

Elettromagneti
Electromagnets

ESECUZIONI SPECIALI SPECIAL REQUESTS



Trasformatori resinati con attacco per guida DIN
Cast-resin transformers with DIN rail coupling



Trasformatori con uscite su cavo
Transformers with cable connections



Trasformatori con telaio a basso profilo
Low-profile-brake transformers



Autotrasformatori
con spina UK e presa USA
*Autotransformers
with USA socket and UK plug*



Trasformatori con portafusibile
Transformers with fuse holder terminal blocks

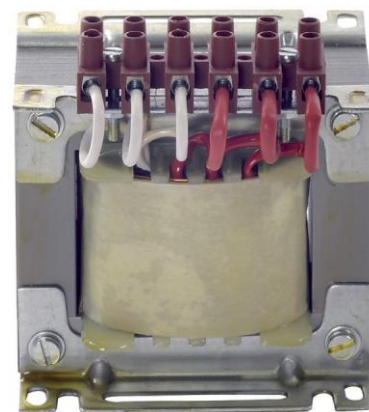

Trasformatori con morsetti mammut
Transformers with mammut terminal blocks

NOTE NOTES

Disegni, misure e pesi sono puramente indicativi. A motivo della continua ricerca allo scopo di migliorare il prodotto, le caratteristiche elettriche e meccaniche possono subire variazioni anche senza preavviso.

Per potenze e tensioni non presenti nelle varie tabelle, per particolari esigenze costruttive o per qualsiasi altro chiarimento, Botter Elettrotecnica mette a disposizione della clientela il proprio ufficio tecnico.

Drawings, measurement and weights are indicative. Continuous research and development in product improvement, has often as a natural consequence products electrical and mechanical features changes, which may be introduced without notice.

For powers and voltages not reported in the tables, for particular design requirements or any other clarification, Botter Elettrotecnica makes available to the customers its technical department.

STOCCAGGIO STORAGE

Il trasformatore, come qualsiasi altro componente elettrico, deve essere conservato in un luogo asciutto, pulito e al riparo dagli agenti atmosferici. Se il trasformatore è conservato con il proprio imballo, specialmente se questo è in cartone, sarà necessario verificare che esso sia integro e non umido al fine di evitare la diffusione della corrosione e il deterioramento dei componenti.

Transformer, like any other electrical component, must be stored in a dry place, clean and protected from atmospheric agents. If the transformer is stored with its packaging, especially if it is made of cardboard, it will be necessary to check that it is intact and not wet, in order to avoid the spread of rust and the deterioration of components.

108

GARANZIA WARRANTY

Il prodotto è garantito a norma di legge. La garanzia decade in caso di uso improprio, manomissione o per il mancato rispetto delle specifiche elencate nel presente catalogo oppure di quelle di consueto uso per il corretto impiego dei trasformatori e della loro installazione a regola d'arte.

Botter Elettrotecnica warrants its products according to law. Warranty will be declared void in case of transformers misuse, tampering, manumission, in case of installation without respecting the specification listed in the present catalogue, in case of not workmanlike installation.

FORNITURE URGENTI URGENT SUPPLIES

Le richieste di fornitura con carattere d'urgenza, cioè con consegne da effettuarsi entro 5 giorni lavorativi dal ricevimento dell'ordine, saranno da concordare preventivamente con l'azienda e subordinate alle possibilità di evasione dell'ordine stesso. Tali richieste potranno subire un costo accessorio aggiuntivo. Per maggiori dettagli al riguardo vi invitiamo a contattare il nostro ufficio commerciale.

Urgent transformers supplies, intended to be delivered within 5 working days, must be agreed and are subjected to production circumstances.

Urgent requests may be subjected to additional costs. For more information and details our commercial office is available to give the necessary support.



CISQ is a member of



The International Certification Network
www.iqnet-certification.com

CERTIFICATO N.
CERTIFICATE No.

ICIM-9001-008579-03

SI CERTIFICA CHE IL SISTEMA DI GESTIONE PER LA QUALITÀ DI
WE HEREBY CERTIFY THAT THE QUALITY MANAGEMENT SYSTEM OPERATED BY

BOTTER ELETTROTECNICA S.R.L.

UNITÀ OPERATIVA / OPERATIVE UNIT

Strada della Serenissima, 12 31057 Silea TV IT - Italia

È CONFORME ALLA NORMA / IS IN COMPLIANCE WITH THE STANDARD

UNI EN ISO 9001:2015

Sistema di Gestione per la Qualità / Quality Management System

PER LE SEGUENTI ATTIVITÀ / FOR THE FOLLOWING ACTIVITIES

EA: 19

Progettazione e produzione di trasformatori e di macchine elettriche statiche.

Design and production of transformers and static electric machines.

Riferirsi alla documentazione del Sistema di Gestione per la Qualità aziendale per l'applicabilità dei requisiti della norma di riferimento.
Refer to the documentation of the Quality Management System for details of application to reference standard requirements.

Il presente certificato è soggetto al rispetto del documento ICIM "Regolamento per la certificazione dei sistemi di gestione" e al relativo Schema specifico.
The use and the validity of this certificate shall satisfy the requirements of the ICIM document "Rules for the certification of company management systems" and specific Scheme.

Per informazioni puntuali e aggiornate circa eventuali variazioni intervenute nello stato della certificazione di cui al presente certificato,
si prega di contattare il n° telefonico +39 02 725341 o indirizzo e-mail info@icim.it.

For timely and updated information about any changes in the certification status referred to in this certificate,
please contact the number +39 02 725341 or email address info@icim.it.

DATA EMISSIONE
FIRST ISSUE
07/07/2003

EMISSIONE CORRENTE
CURRENT ISSUE
06/07/2024

DATA DI SCADENZA
EXPIRING DATE
05/07/2027

Rappresentante Direzione / Management Representative

ICIM S.p.A.

Piazza Don Enrico Mapelli, 75 - 20099 Sesto San Giovanni (MI)
www.icim.it



NS N° 0004



www.cisq.com

CISQ è la Federazione Italiana di Organismi di
Certificazione dei sistemi di gestione aziendale / CISQ
is the Italian Federation of management system
Certification Bodies.

CERTIFICATE

Issued to:
Applicant:
Botter Elettrotecnica S.R.L.
Via Strada della Serenissima, 12
31057 Silea, Italy

Licensee:
Botter Elettrotecnica S.R.L.
Via Strada della Serenissima, 12
31057 Silea, Italy

Product : Control Transformers, single-phase, General Purpose
Trade name(s) : BOTTER
Type(s)/model(s) : TM Series (TM.xxxx.xx.EN)

The product and any acceptable variation thereof as specified in the Annex to this certificate and the documents referred to therein.

DEKRA hereby declares that the above-mentioned product has been certified on the basis of:

- a type test according to EN IEC 61558-1:2019 and EN 61558-2-2:2007
- an inspection of the factory location according to CENELEC Operational Document CIG 021
- a DEKRA certification agreement with the number 6066330

DEKRA hereby grants the right to use the DEKRA Mark.

The DEKRA Mark may be applied to the product as specified in this certificate for the duration and under the conditions of the DEKRA Mark certification agreement.

This certificate is issued on 18 April 2024 and expires upon withdrawal of one of the above mentioned standards.

Certificate number: 81-137798

DEKRA Certification B.V.

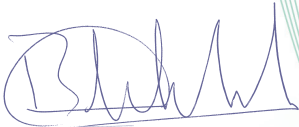

B.T.M. Holtus
Managing Director



Miranda Zhou
Certification Manager

© Integral publication of this certificate is allowed

ACCREDITED BY THE
DUTCH ACCREDITATION
COUNCIL



81-137798

CERTIFICATE

Issued to:

Applicant:

Botter Elettrotecnica S.R.L.
Via Strada della Serenissima, 12
31057 Silea, Italy

Licensee:

Botter Elettrotecnica S.R.L.
Via Strada della Serenissima, 12
31057 Silea, Italy

Product : Isolating Transformer, Single Phase, General Purpose
Trade name(s) : BOTTER
Type(s)/model(s) : TM Series (TM.xxxx.xx.EN)

The product and any acceptable variation thereof as specified in the Annex to this certificate and the documents referred to therein.

DEKRA hereby declares that the above-mentioned product has been certified on the basis of:

- a type test according to EN IEC 61558-1:2019 and EN 61558-2-4:2009
- an inspection of the factory location according to CENELEC Operational Document CIG 021
- a DEKRA certification agreement with the number 6066330

DEKRA hereby grants the right to use the DEKRA Mark.

The DEKRA Mark may be applied to the product as specified in this certificate for the duration and under the conditions of the DEKRA Mark certification agreement.

This certificate is issued on 2 May 2024 and expires upon withdrawal of one of the above mentioned standards.

Certificate number: 81-139269

DEKRA Certification B.V.

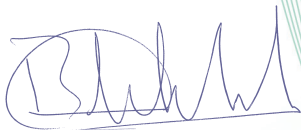

B.T.M. Holtus
Managing Director



H.L. Schendstok
Certification Manager

© Integral publication of this certificate is allowed

ACCREDITED BY THE
DUTCH ACCREDITATION
COUNCIL



81-139269

CERTIFICATE

Issued to:
Applicant:
Botter Elettrotecnica S.R.L.
Via Strada della Serenissima, 12
31057 Silea, Italy

Licensee:
Botter Elettrotecnica S.R.L.
Via Strada della Serenissima, 12
31057 Silea, Italy

Product : Safety Isolating Transformer, Single Phase, General Purpose
Trade name(s) : BOTTER
Type(s)/model(s) : TM Series (TM.xxxx.xx.EN)

The product and any acceptable variation thereto as specified in the Annex to this certificate and the documents therein referred to.

DEKRA hereby declares that the above-mentioned product has been certified on the basis of:

- a type test according to EN IEC 61558-1:2019 and EN 61558-2-6:2009
- an inspection of the factory location according to CENELEC Operational Document CIG 021
- a DEKRA certification agreement with the number 6066330

DEKRA hereby grants the right to use the DEKRA Mark.

The DEKRA Mark may be applied to the product as specified in this certificate for the duration and under the conditions of the DEKRA Mark certification agreement.

This certificate is issued on 21 March 2024 and expires upon withdrawal of one of the above mentioned standards.

Certificate number: 81-137801

DEKRA Certification B.V.

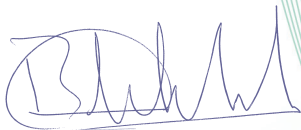

B.T.M. Holtus
Managing Director



Miranda Zhou
Certification Manager

© Integral publication of this certificate is allowed

ACCREDITED BY THE
DUTCH ACCREDITATION
COUNCIL



81-137801

ATTESTATION OF CONFORMITY

TO STANDARDS ATTESTATO DI CONFORMITA' ALLE NORME

Attestation number <i>Attestato numero</i>	: 3509066.01
Issued to <i>Rilasciato a</i>	: BOTTER ELETTROTECNICA S.r.l. Strada della Serenissima, 12 31057 Silea (TV) Italy
Manufacturer <i>Costruttore</i>	: BOTTER ELETTROTECNICA S.r.l. Strada della Serenissima, 12 31057 Silea (TV) Italy
Product Type <i>Tipo prodotto</i>	: Single-phase transformer – “TM” Family
Model reference <i>Riferimento Modello</i>	: TM2306428 TM2306429
Ratings <i>Dati di targa</i>	:  II 3G Ex ec IIC T4 Gc Tamb = -20°C ÷ +60°C
Test Report ref. No. <i>Rapporto di prova Nr.</i>	: Albarubens ATEX Assessment Report Ref. Job 22/0166 - Certificate ID: 4833
Requirements <i>Requisiti</i>	: EN IEC 60079-0:2018 Explosive atmospheres - Part 0: Equipment - General requirements EN IEC 60079-7:2015+A1:2018 Explosive atmospheres - Part 7: Equipment protection by increased safety “e”

The undersigned declares that the above described product meets the above mentioned technical specification. This attestation of conformity is issued based on the test results as laid down in the referred Test Report. The investigation does not include an assessment of the manufacturer's production nor of the factory location.

Il sottoscritto dichiara che il prodotto di cui sopra è conforme ai requisiti tecnici menzionati. Questo attestato di conformità è rilasciato sulla base dei risultati di prova riferiti nel rapporto sopra menzionato. La valutazione non include una verifica della produzione di serie né del luogo di produzione.

Date of issue: 2023-05-02
Emesso in data

Franco Vasta
Executive

Firmato digitalmente da
FRANCO VASTA
Cognome: VASTA, Nome: FRANCO
C=IT, OU=DEKRA S.p.A., CN=Franco Vasta

CERTIFICATE OF COMPLIANCE

Certificate Number UL-US-L253717-111-81405002-0
Report Reference E253717-20050418
Date 13-Oct-2022

Issued to: BOTTER ELETTROTECNICA SRL
Strada Della Serenissima, 12 Silea, TV 31057
Italy

This is to certify that representative samples of OBJY2 - Systems, Electrical Insulation - Component
See Addendum Page for Product Designation(s).

Have been evaluated by UL in accordance with the component requirements in the Standard(s) indicated on this Certificate. UL Recognized components are incomplete in certain constructional features or restricted in performance capabilities and are intended for installation in complete equipment submitted for investigation to UL LLC.

Standard(s) for Safety: UL 1446 - Systems of Insulating Materials – General.

Additional Information: See the UL Online Certifications Directory at <https://iq.ulprospector.com> for additional information

This Certificate of Compliance indicates that representative samples of the product described in the certification report have met the requirements for UL certification. It does not provide authorization to apply the UL Recognized Component Mark. Only the Authorization Page that references the Follow-Up Services Procedure for ongoing surveillance provides authorization to apply the UL Mark.

Only those products bearing the UL Recognized Component Mark should be considered as being UL Certified and covered under UL's Follow-Up Services.

Look for the UL Recognized Component Mark on the product.



Bruce Mahrenholz, Director North American Certification Program

UL LLC

Any information and documentation involving UL Mark services are provided on behalf of UL LLC (UL) or any authorized licensee of UL. For questions, please contact a local UL Customer Service Representative at <http://ul.com/aboutul/locations/>



CERTIFICATE OF COMPLIANCE

Certificate Number UL-CA-L253717-311-81405002-0
Report Reference E253717-20050418
Date 13-Oct-2022

Issued to: BOTTER ELETTROTECNICA SRL
Strada Della Serenissima, 12 Silea, TV 31057
Italy

**This is to certify that
representative samples of**

OBJY8 - Systems, Electrical Insulation Certified for Canada
- Component

See Addendum Page for Product Designation(s).

Have been evaluated by UL in accordance with the component requirements in the Standard(s) indicated on this Certificate. UL Recognized components are incomplete in certain constructional features or restricted in performance capabilities and are intended for installation in complete equipment submitted for investigation to UL LLC.

Standard(s) for Safety: CSA C22.2 NO 0-10 - General requirements — Canadian Electrical Code, Part II.

Additional Information: See the UL Online Certifications Directory at <https://iq.ulprospector.com> for additional information

This Certificate of Compliance indicates that representative samples of the product described in the certification report have met the requirements for UL certification. It does not provide authorization to apply the UL Recognized Component Mark. Only the Authorization Page that references the Follow-Up Services Procedure for ongoing surveillance provides authorization to apply the UL Mark.

Only those products bearing the UL Recognized Component Mark should be considered as being UL Certified and covered under UL's Follow-Up Services.

Look for the UL Recognized Component Mark on the product.



Bruce Mahrenholz, Director North American Certification Program

UL LLC

Any information and documentation involving UL Mark services are provided on behalf of UL LLC (UL) or any authorized licensee of UL. For questions, please contact a local UL Customer Service Representative at <http://ul.com/aboutul/locations/>



CERTIFICATE OF COMPLIANCE

Certificate Number UL-US-L253717-112-50800202-0
Report Reference E253717-20200805
Date 19-Oct-2022

Issued to: BOTTER ELETTROTECNICA SRL
Strada Della Serenissima, 12 Silea, TV 31057
Italy

This is to certify that representative samples of OBJY2 - Systems, Electrical Insulation - Component
See Addendum Page for Product Designation(s).

Have been evaluated by UL in accordance with the component requirements in the Standard(s) indicated on this Certificate. UL Recognized components are incomplete in certain constructional features or restricted in performance capabilities and are intended for installation in complete equipment submitted for investigation to UL LLC.

Standard(s) for Safety: UL 1446 - Systems of Insulating Materials - General

Additional Information: See the UL Online Certifications Directory at <https://iq.ulprospector.com> for additional information

This Certificate of Compliance indicates that representative samples of the product described in the certification report have met the requirements for UL certification. It does not provide authorization to apply the UL Recognized Component Mark. Only the Authorization Page that references the Follow-Up Services Procedure for ongoing surveillance provides authorization to apply the UL Mark.

Only those products bearing the UL Recognized Component Mark should be considered as being UL Certified and covered under UL's Follow-Up Services.

Look for the UL Recognized Component Mark on the product.



Bruce Mahrenholz, Director North American Certification Program

UL LLC

Any information and documentation involving UL Mark services are provided on behalf of UL LLC (UL) or any authorized licensee of UL. For questions, please contact a local UL Customer Service Representative at <http://ul.com/aboutul/locations/>



CERTIFICATE OF COMPLIANCE

Certificate Number UL-CA-L253717-312-50800202-0
Report Reference E253717-20200805
Date 19-Oct-2022

Issued to: BOTTER ELETTROTECNICA SRL
Strada Della Serenissima, 12 Silea, TV 31057
Italy

**This is to certify that
representative samples of**

OBJY8 - Systems, Electrical Insulation Certified for Canada
- Component

See Addendum Page for Product Designation(s).

Have been evaluated by UL in accordance with the component requirements in the Standard(s) indicated on this Certificate. UL Recognized components are incomplete in certain constructional features or restricted in performance capabilities and are intended for installation in complete equipment submitted for investigation to UL LLC.

Standard(s) for Safety: UL 1446 - Systems of Insulating Materials - General

Additional Information: See the UL Online Certifications Directory at <https://iq.ulprospector.com> for additional information

This Certificate of Compliance indicates that representative samples of the product described in the certification report have met the requirements for UL certification. It does not provide authorization to apply the UL Recognized Component Mark. Only the Authorization Page that references the Follow-Up Services Procedure for ongoing surveillance provides authorization to apply the UL Mark.

Only those products bearing the UL Recognized Component Mark should be considered as being UL Certified and covered under UL's Follow-Up Services.

Look for the UL Recognized Component Mark on the product.



Bruce Mahrenholz, Director North American Certification Program

UL LLC

Any information and documentation involving UL Mark services are provided on behalf of UL LLC (UL) or any authorized licensee of UL. For questions, please contact a local UL Customer Service Representative at <http://ul.com/aboutul/locations/>



CERTIFICATE OF COMPLIANCE

Certificate Number E227716
Report Reference E227716-20030227
Issue Date 2020-SEPTEMBER-04

Issued to: BOTTER ELETTROTECNICA SRL
Strada Della Serenissima, 12
31057 Silea TV ITALY

**This certificate confirms that
representative samples of**

COMPONENT - TRANSFORMERS, GENERAL PURPOSE
Model TM., followed by 100. followed by two or three digits
numbers, followed by .UL.

Have been investigated by UL in accordance with the
component requirements in the Standard(s) indicated on
this Certificate. UL Recognized components are incomplete
in certain constructional features or restricted in
performance capabilities and are intended for installation in
complete equipment submitted for investigation to UL LLC.

Standard(s) for Safety:

UL 5085-1 and CSA-C22.2 No. 66.1-06, Low Voltage
Transformers - Part 1: General Requirements
UL 5085-2 and CSA-C22.2 No. 66.2-06, Low Voltage
Transformers - Part 2: General Purpose Transformers

Additional Information:

See the UL Online Certifications Directory at
<https://iq.ulprospector.com> for additional information.

This *Certificate of Compliance* does not provide authorization to apply the UL Recognized Component Mark. Only the UL Follow-Up Services Procedure provides authorization to apply the UL Mark.

Only those products bearing the UL Recognized Component Mark should be considered as being UL Certified and covered under UL's Follow-Up Services.

Look for the UL Recognized Component Mark on the product.



Bruce Mahrenholz, Director North American Certification Program
UL LLC

Any information and documentation involving UL Mark services are provided on behalf of UL LLC (UL) or any authorized licensee of UL. For questions, please contact a local UL Customer Service Representative at <http://ul.com/aboutul/locations/>



CERTIFICATE OF COMPLIANCE

Certificate Number E227716
Report Reference E227716-20030528
Issue Date 2020-SEPTEMBER-04

Issued to: BOTTER ELETTROTECNICA SRL
Strada Della Serenissima, 12
31057 Silea TV ITALY

**This certificate confirms that
representative samples of**

COMPONENT - TRANSFORMERS, GENERAL PURPOSE
TM series followed by 4 digits, followed by two or three
digits numbers, followed by .UL.

Have been investigated by UL in accordance with the
component requirements in the Standard(s) indicated on
this Certificate. UL Recognized components are incomplete
in certain constructional features or restricted in
performance capabilities and are intended for installation in
complete equipment submitted for investigation to UL LLC.

Standard(s) for Safety:

UL 5085-1 and CSA-C22.2 No. 66.1-06, Low Voltage
Transformers - Part 1: General Requirements
UL 5085-2 and CSA-C22.2 No. 66.2-06, Low Voltage
Transformers - Part 2: General Purpose Transformers

Additional Information:

See the UL Online Certifications Directory at
<https://iq.ulprospector.com> for additional information.

This *Certificate of Compliance* does not provide authorization to apply the UL Recognized Component Mark. Only the UL Follow-Up Services Procedure provides authorization to apply the UL Mark.

Only those products bearing the UL Recognized Component Mark should be considered as being UL Certified and covered under UL's Follow-Up Services.

Look for the UL Recognized Component Mark on the product.



Bruce Mahrenholz, Director North American Certification Program
UL LLC

Any information and documentation involving UL Mark services are provided on behalf of UL LLC (UL) or any authorized licensee of UL. For questions, please contact a local UL Customer Service Representative at <http://ul.com/aboutul/locations/>



CERTIFICATE OF COMPLIANCE

Certificate Number UL-US-L227716-213-11701102-1
Report Reference E227716-20110711
Date 8-Apr-2021

Issued to: BOTTER ELETTROTECNICA SRL
Strada Della Serenissima, 12 Silea , TV,
Italy 31057

This is to certify that representative samples of XPTQ2 - Transformers, General Purpose - Component
See Addendum Page for Product Designation(s).

Have been investigated by UL in accordance with the component requirements in the Standard(s) indicated on this Certificate. UL Recognized components are incomplete in certain constructional features or restricted in performance capabilities and are intended for installation in complete equipment submitted for investigation to UL LLC.

Standard(s) for Safety: UL 5085-1, 1st Ed., Issue Date: 2006-04-17, Revision Date: 2018-01-17, UL 5085-2, 1st Ed., Issue Date: 2006-04-17, Revision Date: 2017-11-29

Additional Information: See the UL Online Certifications Directory at <https://iq.ulprospector.com> for additional information

This *Certificate of Compliance* does not provide authorization to apply the UL Recognized Component Mark. Only the UL Follow-Up Services Procedure provides authorization to apply the UL Mark.

Only those products bearing the UL Recognized Component Mark should be considered as being UL Certified and covered under UL's Follow-Up Services.

Look for the UL Recognized Component Mark on the product.



Bruce Mahrenholz, Director North American Certification Program

UL LLC

Any information and documentation involving UL Mark services are provided on behalf of UL LLC (UL) or any authorized licensee of UL. For questions, please contact a local UL Customer Service Representative at <http://ul.com/aboutul/locations/>



CERTIFICATE OF COMPLIANCE

Certificate Number UL-CA-L227716-513-11701102-1
Report Reference E227716-20110711
Date 8-Apr-2021

Issued to: BOTTER ELETTROTECNICA SRL
Strada Della Serenissima, 12 Silea , TV,
Italy 31057

This is to certify that representative samples of XPTQ8 - Transformers, General Purpose Certified for Canada - Component
See Addendum Page for Product Designation(s).

Have been investigated by UL in accordance with the component requirements in the Standard(s) indicated on this Certificate. UL Recognized components are incomplete in certain constructional features or restricted in performance capabilities and are intended for installation in complete equipment submitted for investigation to UL LLC.

Standard(s) for Safety: CSA C22.2 NO. 66.1-06, 1st Ed., Issue Date: 2006-04-17, Revision Date: 2013-12-01, CSA C22.2 NO. 66.2-06, 1st Ed., Issue Date: 2006-04-17, Revision Date: 2012-11-01

Additional Information: See the UL Online Certifications Directory at <https://iq.ulprospector.com> for additional information

This *Certificate of Compliance* does not provide authorization to apply the UL Recognized Component Mark. Only the UL Follow-Up Services Procedure provides authorization to apply the UL Mark.

Only those products bearing the UL Recognized Component Mark should be considered as being UL Certified and covered under UL's Follow-Up Services.

Look for the UL Recognized Component Mark on the product.



Bruce Mahrenholz, Director North American Certification Program

UL LLC

Any information and documentation involving UL Mark services are provided on behalf of UL LLC (UL) or any authorized licensee of UL. For questions, please contact a local UL Customer Service Representative at <http://ul.com/aboutul/locations/>



CERTIFICATE OF COMPLIANCE

Certificate Number UL-US-L227716-214-21701102-3
Report Reference E227716-20110712
Date 22-Sep-2022

Issued to: BOTTER ELETTROTECNICA SRL
Strada Della Serenissima, 12 Silea, TV 31057
Italy

This is to certify that representative samples of XPTQ2 - Transformers, General Purpose - Component
See Addendum Page for Product Designation(s).

Have been evaluated by UL in accordance with the component requirements in the Standard(s) indicated on this Certificate. UL Recognized components are incomplete in certain constructional features or restricted in performance capabilities and are intended for installation in complete equipment submitted for investigation to UL LLC.

Standard(s) for Safety: UL 5085-2, 2nd Ed., Issue Date: 2021-08-16, UL 5085-1, 1st Ed., Issue Date: 2006-04-17, Revision Date: 2022-06-02

Additional Information: See the UL Online Certifications Directory at <https://iq.ulprospector.com> for additional information

This Certificate of Compliance indicates that representative samples of the product described in the certification report have met the requirements for UL certification. It does not provide authorization to apply the UL Recognized Component Mark. Only the Authorization Page that references the Follow-Up Services Procedure for ongoing surveillance provides authorization to apply the UL Mark.

Only those products bearing the UL Recognized Component Mark should be considered as being UL Certified and covered under UL's Follow-Up Services.

Look for the UL Recognized Component Mark on the product.

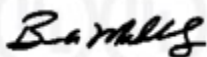

Bruce Mahrenholz, Director North American Certification Program

UL LLC

Any information and documentation involving UL Mark services are provided on behalf of UL LLC (UL) or any authorized licensee of UL. For questions, please contact a local UL Customer Service Representative at <http://ul.com/aboutul/locations/>



CERTIFICATE OF COMPLIANCE

Certificate Number UL-CA-L227716-514-21701102-3
Report Reference E227716-20110712
Date 22-Sep-2022

Issued to: BOTTER ELETTROTECNICA SRL
Strada Della Serenissima, 12 Silea, TV 31057
Italy

This is to certify that representative samples of XPTQ8 - Transformers, General Purpose Certified for Canada - Component
See Addendum Page for Product Designation(s).

Have been evaluated by UL in accordance with the component requirements in the Standard(s) indicated on this Certificate. UL Recognized components are incomplete in certain constructional features or restricted in performance capabilities and are intended for installation in complete equipment submitted for investigation to UL LLC.

Standard(s) for Safety: CSA C22.2 NO. 66.2:21, 2nd Ed., Issue Date: 2021-08-16, CSA C22.2 No. 66.1-06, 1st Ed., Issue Date: 2006-04-17, Revision Date: 2022-06-02

Additional Information: See the UL Online Certifications Directory at <https://iq.ulprospector.com> for additional information

This Certificate of Compliance indicates that representative samples of the product described in the certification report have met the requirements for UL certification. It does not provide authorization to apply the UL Recognized Component Mark. Only the Authorization Page that references the Follow-Up Services Procedure for ongoing surveillance provides authorization to apply the UL Mark.

Only those products bearing the UL Recognized Component Mark should be considered as being UL Certified and covered under UL's Follow-Up Services.

Look for the UL Recognized Component Mark on the product.



Bruce Mahrenholz, Director North American Certification Program

UL LLC



Any information and documentation involving UL Mark services are provided on behalf of UL LLC (UL) or any authorized licensee of UL. For questions, please contact a local UL Customer Service Representative at <http://ul.com/aboutul/locations/>

Certificate of Compliance

Certificate Number:

UL-US-2437636-0

Report Reference:

E227716-20241007

Issue Date:

2024-10-08

Issued to:

BOTTER ELETTROTECNICA SRL
Strada Della Serenissima, 12 Silea, TV 31057
Italy

This certificate confirms that representative samples of:
XPTQ - Transformers, General Purpose

See Addendum Page for Product Designation(s).

Have been evaluated by UL in accordance with the Standard(s) indicated on this Certificate.

UL 5085-1, Edition 1, Issue Date 2006-04-17, Revision Date 2022-06-02, UL 5085-2, 2nd Ed., Issue Date: 2021-08-16

Additional Information:

See UL Product iQ® at <https://iq.ulprospector.com> for additional information.

This Certificate of Compliance indicates that representative samples of the product described in the certification report have met the requirements for UL certification. It does not provide authorization to apply the UL Mark. Only the Authorization Page that references the Follow-Up Services Procedure for ongoing surveillance provides authorization to apply the UL Mark.

Only those products bearing the UL Mark should be considered as being UL Certified and covered under UL's Follow-Up Services.

Look for the UL Certification Mark on the product.



A handwritten signature in black ink, appearing to read 'David Piecuch'.

David Piecuch
UL Mark Certification Program Owner

Any information and documentation involving UL Mark services are provided on behalf of UL LLC (UL) or any authorized licensee of UL. For questions, please contact UL Solutions Customer Service at <https://www.ul.com/contact-us>.

Certificate of Compliance

Certificate Number:

UL-CA-2428749-0

Report Reference:

E227716-20241007

Issue Date:

2024-10-08

Issued to:

BOTTER ELETTROTECNICA SRL
Strada Della Serenissima, 12 Silea, TV 31057
Italy

This certificate confirms that representative samples of:
XPTQ7 - Transformers, General Purpose Certified for Canada

See Addendum Page for Product Designation(s).

Have been evaluated by UL in accordance with the Standard(s) indicated on this Certificate.

CSA C22.2 No. 66.1, 1st Ed., Issue Date: 2006-04-01, Revision Date: 2013-12-01, CSA C22.2 NO. 66.2:21, 2nd Ed., Issue Date: 2021-08-16

Additional Information:

See UL Product iQ® at <https://iq.ulprospector.com> for additional information.

This Certificate of Compliance indicates that representative samples of the product described in the certification report have met the requirements for UL certification. It does not provide authorization to apply the UL Mark. Only the Authorization Page that references the Follow-Up Services Procedure for ongoing surveillance provides authorization to apply the UL Mark.

Only those products bearing the UL Mark should be considered as being UL Certified and covered under UL's Follow-Up Services.

Look for the UL Certification Mark on the product.



A handwritten signature in black ink, appearing to read 'David Piecuch'.

David Piecuch
UL Mark Certification Program Owner

Any information and documentation involving UL Mark services are provided on behalf of UL LLC (UL) or any authorized licensee of UL. For questions, please contact UL Solutions Customer Service at <https://www.ul.com/contact-us>.

Certificate of Compliance

Certificate Number:

UL-US-2437637-0

Report Reference:

E227716-20241008

Issue Date:

2024-10-08

Issued to:

BOTTER ELETTROTECNICA SRL
Strada Della Serenissima, 12 Silea, TV 31057
Italy

This certificate confirms that representative samples of:

XPTQ - Transformers, General Purpose

See Addendum Page for Product Designation(s).

Have been evaluated by UL in accordance with the Standard(s) indicated on this Certificate.

UL 5085-1, Edition 1, Issue Date 2006-04-17, Revision Date 2022-06-02, UL 5085-2, 2nd Ed., Issue Date: 2021-08-16

Additional Information:

See UL Product iQ® at <https://iq.ulprospector.com> for additional information.

This Certificate of Compliance indicates that representative samples of the product described in the certification report have met the requirements for UL certification. It does not provide authorization to apply the UL Mark. Only the Authorization Page that references the Follow-Up Services Procedure for ongoing surveillance provides authorization to apply the UL Mark.

Only those products bearing the UL Mark should be considered as being UL Certified and covered under UL's Follow-Up Services.

Look for the UL Certification Mark on the product.



A handwritten signature in black ink, appearing to read 'David Piecuch'.

David Piecuch
UL Mark Certification Program Owner

Any information and documentation involving UL Mark services are provided on behalf of UL LLC (UL) or any authorized licensee of UL. For questions, please contact UL Solutions Customer Service at <https://www.ul.com/contact-us>.

Certificate of Compliance

Certificate Number:

UL-CA-2428750-0

Report Reference:

E227716-20241008

Issue Date:

2024-10-08

Issued to:

BOTTER ELETTROTECNICA SRL
Strada Della Serenissima, 12 Silea, TV 31057
Italy

This certificate confirms that representative samples of:
XPTQ7 - Transformers, General Purpose Certified for Canada

See Addendum Page for Product Designation(s).

Have been evaluated by UL in accordance with the Standard(s) indicated on this Certificate.

CSA C22.2 No. 66.1, 1st Ed., Issue Date: 2006-04-01, Revision Date: 2013-12-01, CSA C22.2 NO. 66.2:21, 2nd Ed., Issue Date: 2021-08-16

Additional Information:

See UL Product iQ® at <https://iq.ulprospector.com> for additional information.

This Certificate of Compliance indicates that representative samples of the product described in the certification report have met the requirements for UL certification. It does not provide authorization to apply the UL Mark. Only the Authorization Page that references the Follow-Up Services Procedure for ongoing surveillance provides authorization to apply the UL Mark.

Only those products bearing the UL Mark should be considered as being UL Certified and covered under UL's Follow-Up Services.

Look for the UL Certification Mark on the product.



A handwritten signature in black ink that reads 'David Piecuch'.

David Piecuch
UL Mark Certification Program Owner

Any information and documentation involving UL Mark services are provided on behalf of UL LLC (UL) or any authorized licensee of UL. For questions, please contact UL Solutions Customer Service at <https://www.ul.com/contact-us>.



ЕВРАЗИЙСКИЙ ЭКОНОМИЧЕСКИЙ СОЮЗ ДЕКЛАРАЦИЯ О СООТВЕТСТВИИ

Заявитель Общество с ограниченной ответственностью "УорлдУайдБридж". Место нахождения и адрес места осуществления деятельности: 119270, город Москва, Лужнецкая набережная, дом 2/4, строение 3, офис 304, Российская Федерация, Основной государственный регистрационный номер: 1177746256676, телефон: +74957878770, адрес электронной почты: Info@wwbridge.org

в лице Генерального директора Максюковой Ксении Андреевны

заявляет, что Индукторы модели: IM, IT.

Изготовитель "BOTTER ELETTROTECNICA S.R.L."

Место нахождения и адрес места осуществления деятельности по изготовлению продукции: Strada della Serenissima, 12, 31057 Silea (TV), Италия. Координаты: 45.649332, 12.315446

Код ТН ВЭД ЕАЭС 8504 50 950 0, серийный выпуск

Соответствует требованиям Технического регламента Таможенного союза ТР ТС 004/2011 "О безопасности низковольтного оборудования".

Декларация о соответствии принята на основании Протоколов испытаний: №2106417-211110 от 10.11.2021, №2148313-211211 от 11.12.2021, выданных лабораторией изготовителя "BOTTER ELETTROTECNICA S.R.L.". Руководства по эксплуатации.

Схема декларирования: 1д

Дополнительная информация

ГОСТ IEC 61558-2-4-2015 «Безопасность трансформаторов, реакторов, блоков питания и аналогичного оборудования с напряжением питания до 1100 В. Часть 2-4. Дополнительные требования и испытания изолирующих трансформаторов и блоков питания с изолирующими трансформаторами», ГОСТ IEC 61558-1-2012 «Безопасность силовых трансформаторов, источников питания, электрических реакторов и аналогичных изделий. Часть 1. Общие требования и методы испытаний», ГОСТ IEC 61558-2-6-2012 «Безопасность трансформаторов, электрических реакторов, источников питания и аналогичных изделий с напряжением питания до 1100 В. Часть 2-6. Дополнительные требования и методы испытаний безопасных разделительных трансформаторов и источников питания с безопасными разделительными трансформаторами».

Условия и сроки хранения, срок службы согласно эксплуатационной документации.

Декларация о соответствии действительна с даты регистрации по 08.03.2025 включительно

(подпись)

М.П.

Максюкова Ксения Андреевна

(Ф. И. О. заявителя)

Регистрационный номер декларации о соответствии: ЕАЭС № RU Д-IT.РА02.В.32954/22

Дата регистрации декларации о соответствии: 09.03.2022



ЕВРАЗИЙСКИЙ ЭКОНОМИЧЕСКИЙ СОЮЗ ДЕКЛАРАЦИЯ О СООТВЕТСТВИИ

Заявитель Общество с ограниченной ответственностью "УорлдУайдБридж". Место нахождения и адрес места осуществления деятельности: 119270, город Москва, Лужнецкая набережная, дом 2/4, строение 3, офис 304, Российская Федерация, Основной государственный регистрационный номер: 1177746256676, телефон: +74957878770, адрес электронной почты: Info@wwbridge.org

в лице Генерального директора Максюковой Ксении Андреевны

заявляет, что Трансформаторы и автотрансформаторы переменного тока модели: ТМ, ТТ, АМ, АТ, ТР.

Изготовитель "BOTTER ELETTROTECNICA S.R.L."

Место нахождения и адрес места осуществления деятельности по изготовлению продукции: Strada della Serenissima, 12, 31057 Silea (TV), Италия. Координаты: 45.649332, 12.315446

Код ТН ВЭД ЕАЭС 8504 31 800 1; 8504 32 000 9; 8504 33 000 9, серийный выпуск

Соответствует требованиям Технического регламента Таможенного союза ТР ТС 004/2011 "О безопасности низковольтного оборудования".

Декларация о соответствии принята на основании Протоколов испытаний: №2139512-211029 от 29.10.2021, №2205434-220128 от 28.01.2022, №1712113-220125 и №2127203-220125 от 25.01.2022, №1716410-220129 от 29.01.2022, выданных лабораторией изготовителя "BOTTER ELETTROTECNICA S.R.L.". Руководства по эксплуатации.

Схема декларирования: 1д

Дополнительная информация

ГОСТ IEC 61558-2-4-2015 «Безопасность трансформаторов, реакторов, блоков питания и аналогичного оборудования с напряжением питания до 1100 В. Часть 2-4. Дополнительные требования и испытания изолирующих трансформаторов и блоков питания с изолирующими трансформаторами», ГОСТ IEC 61558-1-2012 «Безопасность силовых трансформаторов, источников питания, электрических реакторов и аналогичных изделий. Часть 1. Общие требования и методы испытаний», ГОСТ IEC 61558-2-6-2012 «Безопасность трансформаторов, электрических реакторов, источников питания и аналогичных изделий с напряжением питания до 1100 В. Часть 2-6. Дополнительные требования и методы испытаний безопасных разделительных трансформаторов и источников питания с безопасными разделительными трансформаторами»; ГОСТ IEC 61558-2-13-2015 «Безопасность силовых трансформаторов, источников питания, реакторов и аналогичных изделий. Часть 2-13. Дополнительные требования и методы испытаний автотрансформаторов и блоков питания с автотрансформаторами».

Условия и сроки хранения, срок службы согласно эксплуатационной документации.

Декларация о соответствии действительна с даты регистрации по 08.03.2025 включительно

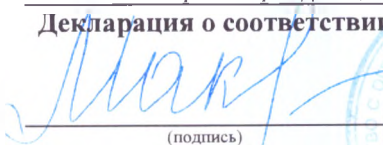
(подпись)

М.П.

Максюкова Ксения Андреевна

(Ф. И. О. заявителя)

Регистрационный номер декларации о соответствии: ЕАЭС № RU Д-ИТ.РА02.В.33065/22

Дата регистрации декларации о соответствии: 09.03.2022



botter[®]

ELECTRICAL TECHNOLOGY SINCE 1943



Botter Elettrotecnica S.r.l.
Strada della Serenissima, 12 – 31057 Silea (TV)
Tel. +39 0422 361 003
www.botter.com info@botter.com